

## PLL FREQUENCY SYNTHESIZER AND CONTROLLER FOR FM/MW/LW TUNER

The DMC 4001 is CMOS LSI chips developed for world-wide FM / MW / LW tuning with PLL frequency synthesizer system. The DMC 4001 can make a compact and high performance FM / MW / LW tuner with clock function for high-end car stereo, home stereo and so on because these CMOS LSIs are in 64-pin QFP package with built-in PLL frequency synthesizer, controller, 200 MHz prescaler, LCD driver and IF counter.

### □ FUNCTIONS

#### RADIO FUNCTIONS

- (1) Manual tuning  
Manual tuning up/down ..... Stepped tuning and rapid tuning.
- (2) Auto tuning  
Seek up/down ..... Retaining the frequency of a station received.  
Scan up/down ..... Receiving in intervals of 5 seconds.
- (3) Preset memory scanning ..... Receiving the contents of preset memories on the FM, MW, and LW bands for 5 seconds each.
- (4) VF auto - tuning  
SK seek up/down .... Retaining the frequency of a SK signal received.  
SK scan up/down .... Receiving a station with SK signal in intervals of 5 seconds.
- (5) Preset memories  
FM band .... FM 1 : 6 stations, FM 2 : 6 stations, FM 3 : 6 stations  
MW band ... MW 1 : 6 stations, MW 2 : 6 stations  
LW band ... 6 stations  
VF band .... 6 stations  
MW2 cannot be used while the LW band is used.
- (6) Last-preset memories .....1 station on the FM1, FM2, FM3, MW1, MW2, LW and VF bands each.
- (7) LOC (local) control signal outputs and indications.
- (8) FM MONO (monaural) control signal output and indication.(For VF bands, same as for FM)
- (9) "ST" (stereo) indicator ..... Enabled on the FM and VF bands.
- (10) Auto-preset memories
- (11) DK stand-by and SK alarm function

#### TAPE FUNCTIONS

- (1) Tape transport direction indicators ..... Can flash at 2 Hz during fast forward.
- (2) AMS (auto music search) control signal output and indication.
- (3) MTL (metal) control signal output and indication.
- (4) NR1 (noise reduction) and NR2 control outputs and indications.

## FUNCTIONS (continued)

### CLOCK FUNCTIONS

- (1) Selectable 12-hour (with AM and PM indicators) or 24-hour display.
- (2) Selectable flashing colon(:) (1Hz).
- (3) Low-power (10  $\mu$ A) backup available in the NOCLK(no-clock) mode.

### OTHERS

- (1) LOUD (loudness) control signal output and indication ..... common to radio, tape, and CD modes.
- (2) Key acknowledge (beep) signal outputs (2.25 kHz, 40ms) ..... Enabled by valid momentary keys.
- (3) Display selector and priority display function.
- (4) "CD" (compact disk) indicator.

Table) Receiving frequency, channel spacing, reference frequency, intermediate frequency

AREA	ITEM		RECEIVING FREQUENCY	CHANNEL SPACE	REFERENCE FREQUENCY	INTERMEDIATE FREQUENCY
	BAND					
Europe 1	FM		87.5 to 108.0 MHz	50kHz	25kHz	10.7MHz
	MW		522 to 1620 kHz	9kHz	9kHz	450kHz
	LW		144 to 290 kHz	1kHz	1kHz	450kHz
Europe 2	FM		87.5 to 108.0 MHz	50kHz	25kHz	10.7MHz
	MW		522 to 1620 kHz	9kHz	9kHz	459kHz
	LW		144 to 290kHz	1kHz	1kHz	459kHz
U.S.A 1	FM		87.5 to 108.0 MHz	100kHz	25kHz	10.7MHz
	MW		530 to 1620 kHz	10kHz	10kHz	450kHz
U.S.A 2	FM		87.5 to 107.9 MHz	200kHz	25kHz	10.7MHz
	MW		530 to 1620 kHz	10kHz	10kHz	450kHz
U.S.A 3	FM		87.5 to 107.9 MHz	200kHz	25kHz	10.7MHz
	MW		530 to 1710 kHz	10kHz	10kHz	450kHz
Australia and Middle and Near East	FM		87.5 to 108.0 MHz	100kHz	25kHz	10.7MHz
	MW		531 to 1602 kHz	9kHz	9kHz	450kHz
Japan	FM		76.0 to 90.0 MHz	100kHz	25kHz	- 10.7MHz
	MW		522 to 1629 kHz	9kHz	9kHz	450kHz
Latin America	FM		87.5 to 108.0 MHz	100kHz	25kHz	10.7MHz
	MW		520 to 1620 kHz	5kHz	5kHz	450kHz

## □ FEATURES

Single power supply of  $5V \pm 10\%$

Built-in prescaler (200 MHz MAX.  $V_{in} = 0.3 V_{p-p}$ ), IF counter and LCD driver (1/2 duty, 1/2 bias, frame frequency: 100Hz)

Capable of receiving FM and MW in the whole world and LW in Europe.

Tuning function..... Manual tuning, auto-tuning (seek and scan) and preset memory scan.

Independent preset memory programming by six buttons for up to 18 FM stations (six FM1, FM2 and FM3 stations each), up to 12 MW stations (six MW1 and MW2 stations each), up to six LW stations and VF broadcasting stations.

Each last channel memory for FM : 3, MW : 1 and VF : 1

VF auto-tuning (SK signal search) with DK stand-by function.

Control output of MONO and LOC (LOCAL / DX) and its display.

Stereo display (ST)

Control output of MTL (METAL), NR<sub>1</sub> (NOISE REDUCTION), NR<sub>2</sub> and AMS (AUTO MUSIC SEARCH) and its display.

Automatic preset station memory function

Compact disc display (  )

Loudness control output and its display

Built-in 12 hour/24 hour clock display function (possible to set no clock)

# DMC 4001

## □ PIN CONFIGURATION

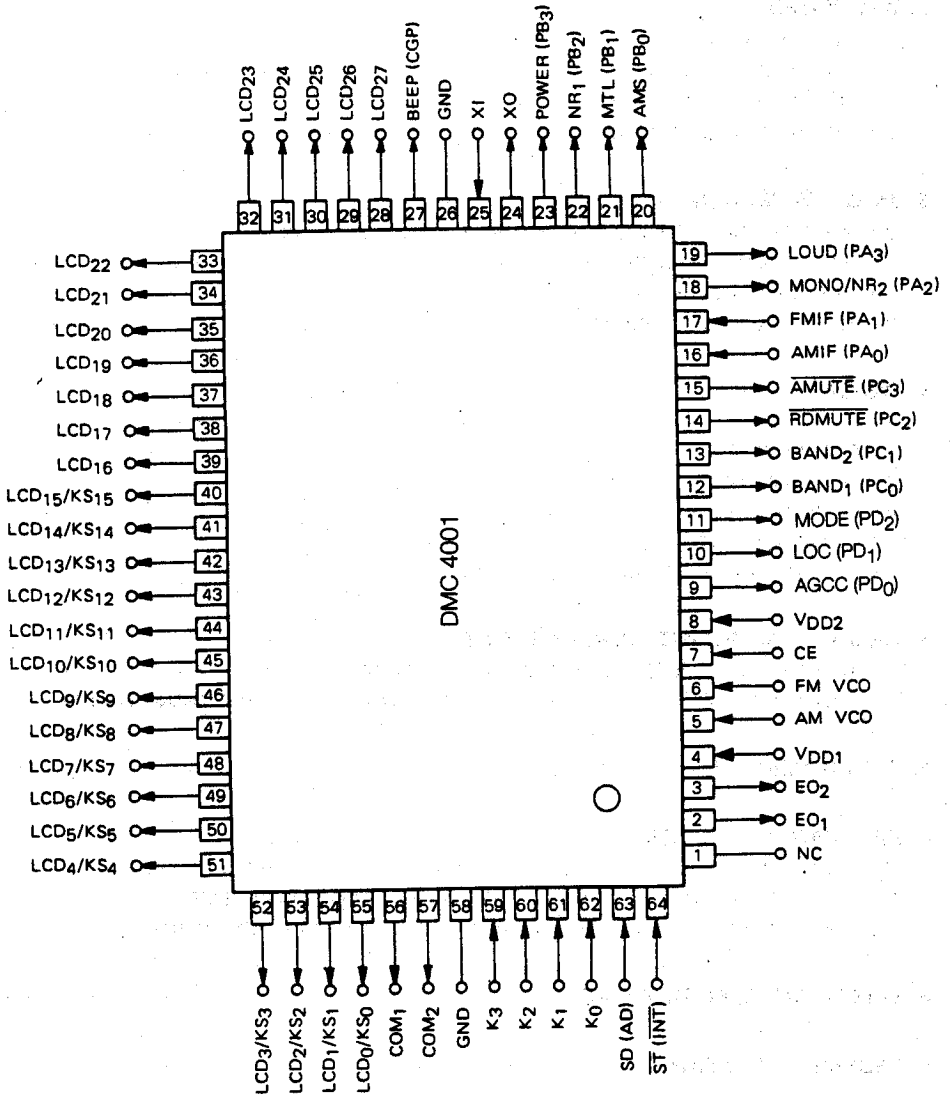

## □ CONTENTS

<b>1. PIN DESCRIPTION</b> .....	<b>425</b>
<b>2. KEY MATRIX</b> .....	<b>434</b>
2.1 KEY MATRIX LAYOUT .....	<b>434</b>
2.2 SWITCH CONNECTION .....	<b>434</b>
2.3 KEY MATRIX CONNECTION .....	<b>435</b>
2.4 DESCRIPTION OF KEY MATRIX .....	<b>436</b>
<b>3. MODE TRANSITION</b> .....	<b>470</b>
3.1 WHEN THE INITIALIZED DIODE RDON=1(RADIO ON/OFF BY CE PIN) .....	<b>470</b>
3.2 RADIO ON/OFF BY RDSET SWITCH .....	<b>472</b>
3.3 DESCRIPTION OF EACH MODE .....	<b>474</b>
3.4 RADIO ON/OFF BY <span style="border: 1px solid black; padding: 2px;">POWER</span> KEY .....	<b>475</b>
<b>4. DISPLAY</b> .....	<b>476</b>
4.1 LCD PANEL .....	<b>476</b>
4.2 DISPLAY TYPE .....	<b>476</b>
4.3 SEGMENT LINES .....	<b>476</b>
4.4 COMMON LINES .....	<b>476</b>
4.5 LCD ASSIGNMENT TABLE .....	<b>477</b>
4.6 DESCRIPTION OF DISPLAYS .....	<b>478</b>
<b>5. RADIO MUTE OUTPUT TIMING (RDMUTE)</b> .....	<b>480</b>
5.1 RADIO MUTE (RDMUTE PIN) OUTPUT TIMING CHARTS .....	<b>480</b>
5.2 RADIO MUTE (RDMUTE PIN) AND AUDIO MUTE (AMUTE PIN) OUTPUT TIMING CHARTS .....	<b>484</b>
<b>6. PIN I/O CIRCUITS</b> .....	<b>486</b>
<b>7. APPLICATION CIRCUITS</b> .....	<b>488</b>
7.1 POWER ON/OFF (NO CLOCK DISPLAY AT POWER OFF) BY ALTERNATE SWITCH .....	<b>488</b>
7.2 POWER ON/OFF (CLOCK DISPLAY AT POWER OFF) BY ALTERNATE SWITCH .....	<b>489</b>
7.3 POWER ON/OFF (CLOCK DISPLAY AT POWER OFF) BY MOMENTARY SWITCH .....	<b>490</b>
<b>8. ELECTRICAL SPECIFICATIONS</b> .....	<b>491</b>
<b>9. PACKAGE DIMENSION</b> .....	<b>493</b>

## 1. PIN DESCRIPTION

PIN No.	SYMBOL	FUNCTION	DESCRIPTION	OUTPUT TYPE
1	NC	No connection	This pin is not connected to the internal chip. Therefore, leave it open or connect it to GND, V <sub>DD</sub> , etc.	
2 3	EO <sub>1</sub> EO <sub>2</sub>	Error out	<p>PLL (Phase Locked Loop) error output pins.</p> <p>When the frequency obtained by dividing the local oscillation frequency, (VCO output) is higher than the reference frequency. High level is output from these pins. When it is lower than the reference frequency.</p> <p>Low level is output from these pins. When the two frequencies are the same, these pins are floated.</p> <p>This output is input to an external LPF (Low Pass Filter) and is applied to a varactor diode through the LPF. EO<sub>1</sub> and EO<sub>2</sub> output the same waveform so that the pin to be used can be freely selected. When the radio is OFF, these pins are floated.</p>	CMOS 3-state
4 8	V <sub>DD1</sub> V <sub>DD2</sub>	Power supply input	<p>Device power supply input pin.</p> <p>This pin supplies <math>5V \pm 10\%</math> power voltage during device operation (radio, tape, and CD modes). When the diode matrix NOCLK switch is 1 (shorted by diode), when the CE pin (pin 7) is made Low level, this pin drops to 2.5V and data hold is enabled. When a voltage of 0 → 4.5V is supplied to this pin, the data is initialized.</p> <p>Supply 0 → 4.5V to this pin within 500 ms.</p> <p>Always connect pins 4 and 8 to the same potential. V<sub>DD1</sub>(pin 4) is the analog system (PLL, A/D converter, INT, CE) power supply and V<sub>DD2</sub>(pin 8) is the digital system (CPU, LCD driver, IF counter) power supply.</p>	
5	AM	AM local oscillation input	<p>The AM (MW and LW band) local oscillation output (VCO output) is input to this pin. When the radio is turned on and the MW or LW band is received, this pin becomes active. Otherwise, it is pulled down internally.</p> <p>The input amplitude is 0.3 V<sub>P-P</sub> MIN.</p> <p>Since there is an on-chip AC amplifier, block the DC component with a capacitor.</p>	Input
6	FM	FM local oscillation input	<p>The FM local oscillation output (VCO output) is input to this pin.</p> <p>When the radio is turned on and the FM band is received, this pin becomes active. Otherwise, it is pulled down internally.</p> <p>The input amplitude is 0.3 V<sub>P-P</sub> MIN.</p> <p>Since there is an on-chip AC amplifier, block the DC component of the input signal with a capacitor.</p>	Input

PIN No.	SYMBOL	FUNCTION	DESCRIPTION	OUTPUT TYPE
7	CE	Chip enable	<p>Device select signal input pin.</p> <p>When the device is operated normally (radio, tape, CD, clock display, etc.), High level is input and when the device is not used, Low level is input.</p> <p>However, High and Low levels of 134<math>\mu</math>s or less are not accepted.</p> <p>When this pin is Low level, the radio, tape, CD and display are turned off and the device enters the data hold state.</p> <p>At this time, data hold at low consumption current (10<math>\mu</math>A or less) is possible by setting the NOCLK switch of the diode matrix to be described later to 1 (shorted by diode, no-clock mode.)</p>	Input
9	AGCC	AGC cut output	<p>Radio mode AGC(AUTOMATIC GAIN CONTROL) cut signal output pin.</p> <p>During autotuning, the High level shown below is output.</p> <div style="text-align: center;"> <p style="font-size: small;">             ① Key on chattering wait              ② Pre-muting              ③ Post-muting           </p> </div>	CMOS pushpull
10	LOC	Local output	<p>Radio mode LOCAL signal output pin.</p> <p>This pin is valid when the initialized diode AUTOLOC switch is 0.</p> <p>Each time the <span style="border: 1px solid black; padding: 2px;">LOC</span> key is pressed, the LOCAL state is inverted. In the LOCAL state, the LCD panel "LOC" display lights.</p> <p>When autotuning(seek up/down, scan up/down, auto preset memory) is performed when the "LOC" display is ON.</p> <p>High level is output from this pin. The LOCAL state is common to the FM, VF, MW and LW bands.</p> <p>When the power is turned on, this pin goes low.</p>	CMOS pushpull

# DMC 4001

PIN No.	SYMBOL	FUNCTION	DESCRIPTION	OUTPUT TYPE																					
11	MODE	Mode signal output	<p>Mode switching signal output pin. Its output in each mode is shown below.</p> <table border="1" style="width: 100%; border-collapse: collapse; margin-bottom: 10px;"> <thead> <tr> <th style="width: 70%;">Mode</th> <th style="width: 30%;">MODE</th> </tr> </thead> <tbody> <tr> <td>CE = Low</td> <td style="text-align: center;">0</td> </tr> <tr> <td>CE = High ; radio, tape and CD OFF</td> <td style="text-align: center;">0</td> </tr> <tr> <td>Radio mode</td> <td style="text-align: center;">1</td> </tr> <tr> <td>Tape mode</td> <td style="text-align: center;">0</td> </tr> <tr> <td>CD mode</td> <td style="text-align: center;">0</td> </tr> <tr> <td>Tape DK standby</td> <td style="text-align: center;">1</td> </tr> <tr> <td>CD DK standby</td> <td style="text-align: center;">1</td> </tr> <tr> <td>DK ON</td> <td style="text-align: center;">1</td> </tr> <tr> <td>Radio monitor mode</td> <td style="text-align: center;">1</td> </tr> </tbody> </table> <p style="text-align: right;">(0:Low level, 1:High level)</p> <p>That is, when the PLL is operated, High level is output from this pin. Therefore, use it to turn the tuner power on and off, etc.</p>	Mode	MODE	CE = Low	0	CE = High ; radio, tape and CD OFF	0	Radio mode	1	Tape mode	0	CD mode	0	Tape DK standby	1	CD DK standby	1	DK ON	1	Radio monitor mode	1	CMOS pushpull	
Mode	MODE																								
CE = Low	0																								
CE = High ; radio, tape and CD OFF	0																								
Radio mode	1																								
Tape mode	0																								
CD mode	0																								
Tape DK standby	1																								
CD DK standby	1																								
DK ON	1																								
Radio monitor mode	1																								
12 13	BAND1, BAND2	Band switching signal output	<p>Radio mode band switching signal output pin. Its operation is described below.</p> <ul style="list-style-type: none"> <li>- Radio mode</li> <li style="padding-left: 20px;">When the receiving band is switched by band switching key, the following is output on each band:</li> <li>- DK standby mode</li> </ul> <table border="1" style="width: 100%; border-collapse: collapse; margin-bottom: 10px;"> <thead> <tr> <th style="width: 20%;">Pin BAND</th> <th style="width: 30%;">BAND<sub>1</sub></th> <th style="width: 30%;">BAND<sub>2</sub></th> </tr> </thead> <tbody> <tr> <td>MW</td> <td style="text-align: center;">0</td> <td style="text-align: center;">0</td> </tr> <tr> <td>LW</td> <td style="text-align: center;">0</td> <td style="text-align: center;">1</td> </tr> <tr> <td>FM</td> <td style="text-align: center;">1</td> <td style="text-align: center;">0</td> </tr> <tr> <td>VF</td> <td style="text-align: center;">1</td> <td style="text-align: center;">1</td> </tr> </tbody> </table> <p style="text-align: right;">(0:Low level, 1:High level)</p> <ul style="list-style-type: none"> <li>- DK standby mode</li> <li>- DK ON mode</li> </ul> <table border="1" style="width: 100%; border-collapse: collapse; margin-bottom: 10px;"> <thead> <tr> <th style="width: 20%;">Pin BAND</th> <th style="width: 30%;">BAND<sub>1</sub></th> <th style="width: 30%;">BAND<sub>2</sub> /OPT.</th> </tr> </thead> <tbody> <tr> <td>VF</td> <td style="text-align: center;">1</td> <td style="text-align: center;">1</td> </tr> </tbody> </table> <ul style="list-style-type: none"> <li>- Radio monitor mode</li> <li style="padding-left: 20px;">Same as radio mode.</li> <li>- Tape mode</li> <li>- CD mode</li> <li style="padding-left: 20px;">Low level output</li> </ul>	Pin BAND	BAND <sub>1</sub>	BAND <sub>2</sub>	MW	0	0	LW	0	1	FM	1	0	VF	1	1	Pin BAND	BAND <sub>1</sub>	BAND <sub>2</sub> /OPT.	VF	1	1	CMOS pushpull
Pin BAND	BAND <sub>1</sub>	BAND <sub>2</sub>																							
MW	0	0																							
LW	0	1																							
FM	1	0																							
VF	1	1																							
Pin BAND	BAND <sub>1</sub>	BAND <sub>2</sub> /OPT.																							
VF	1	1																							



PIN No.	SYMBOL	FUNCTION	DESCRIPTION	OUTPUT TYPE
14	<u>RDMUTE</u>	Radio mute output	<p>Radio mute signal output pin.</p> <p>This pin operates as follows:</p> <ul style="list-style-type: none"> <li>- Radio mode Low level is output at radio ON/OFF, band switching, and receiving frequency switching.</li> <li>- Tape and CD modes High level or Low level can be selected by MUTESEL switch of the diode matrix to be described later.</li> </ul> <p>However, when using the DK standby or radio monitor function, set the MUTESEL switch to 0 and select low level output.</p> <p>For more information, see "Mute Output Timing Chart".</p>	CMOS pushpull
15	<u>AMUTE</u>	Audio mute output	<p>Tape and CD mute signal output pin at DK ON and radio monitor ON.</p> <p>In the radio mode, Low level is output and in the tape and CD modes, High level is output. When DK is turned on during DK standby and in the radio monitor mode, Low level is output.</p> <p>For more information, see "Mute Output Timing Chart".</p>	CMOS pushpull

PIN No.	SYMBOL	FUNCTION	DESCRIPTION	OUTPUT TYPE																						
16	AM IF	AM intermediate frequency input	<p>AM (MW and LW bands) intermediate frequency (IF) input pin.</p> <p>The input amplitude is 0.1 V<sub>P-P</sub>. Since there is an on-chip AC amplifier, block the DC component of the input signal with a capacitor. This pin is valid when the initialized diode matrix DISAMIF switch is 0.</p> <p>This pin is used for detecting the presence of a broadcast station during MW and LW band autotuning. The input frequency ranges and input conditions for determining the presence of a broadcast station are shown below.</p> <table border="1" style="width: 100%; border-collapse: collapse; margin: 10px 0;"> <thead> <tr> <th style="text-align: center;">Area \ Item</th> <th style="text-align: center;">Band</th> <th style="text-align: center;">Input Frequency Range ①(kHz)</th> <th style="text-align: center;">Input Frequency Range ②(kHz)</th> </tr> </thead> <tbody> <tr> <td rowspan="2" style="text-align: center;">Europe 1</td> <td style="text-align: center;">MW</td> <td style="text-align: center;">450 ± 5</td> <td style="text-align: center;">450 ± 2</td> </tr> <tr> <td style="text-align: center;">LW</td> <td style="text-align: center;">450 ± 5</td> <td style="text-align: center;">450 ± 0.5</td> </tr> <tr> <td rowspan="2" style="text-align: center;">Europe 2</td> <td style="text-align: center;">MW</td> <td style="text-align: center;">459 ± 5</td> <td style="text-align: center;">459 ± 2</td> </tr> <tr> <td style="text-align: center;">LW</td> <td style="text-align: center;">459 ± 5</td> <td style="text-align: center;">459 ± 0.5</td> </tr> <tr> <td style="text-align: center;">Others</td> <td style="text-align: center;">MW</td> <td style="text-align: center;">450 ± 5</td> <td style="text-align: center;">450 ± 0.5</td> </tr> </tbody> </table> <p>Input frequency range ① is the frequency that must be input within 20 ms after the PLL is locked.</p> <p>Input frequency range ② is the frequency that must be input within 40 ms after ① was input.</p> <p>When both input frequency ranges ① and ② are satisfied, a broadcast station is judged to be present and autotuning stops.</p>	Area \ Item	Band	Input Frequency Range ①(kHz)	Input Frequency Range ②(kHz)	Europe 1	MW	450 ± 5	450 ± 2	LW	450 ± 5	450 ± 0.5	Europe 2	MW	459 ± 5	459 ± 2	LW	459 ± 5	459 ± 0.5	Others	MW	450 ± 5	450 ± 0.5	Input
Area \ Item	Band	Input Frequency Range ①(kHz)	Input Frequency Range ②(kHz)																							
Europe 1	MW	450 ± 5	450 ± 2																							
	LW	450 ± 5	450 ± 0.5																							
Europe 2	MW	459 ± 5	459 ± 2																							
	LW	459 ± 5	459 ± 0.5																							
Others	MW	450 ± 5	450 ± 0.5																							
17	FM IF	FM intermediate frequency input	<p>FM band intermediate frequency (IF) input.</p> <p>The input amplitude is 0.1 V<sub>P-P</sub>. Since there is an AC amplifier on the chip, block the DC component of the input signal with a capacitor. This pin is valid when the initialized diode matrix switch ENFMIF is 1.</p> <p>This pin is used for detecting the presence of a broadcast station during FM band autotuning. The input frequency ranges and input conditions for determining the presence of a broadcast station are shown below.</p> <table border="1" style="width: 100%; border-collapse: collapse; margin: 10px 0;"> <thead> <tr> <th style="text-align: center;">Area \ Item</th> <th style="text-align: center;">Input Frequency Range ①</th> <th style="text-align: center;">Input Frequency Range ②</th> </tr> </thead> <tbody> <tr> <td style="text-align: center;">All areas</td> <td style="text-align: center;">10.7 MHz ± 50kHz</td> <td style="text-align: center;">10.7 MHz ± 12.5kHz</td> </tr> </tbody> </table> <p>Input frequency range ① is the frequency that must be input within 20 ms after the PLL is locked.</p> <p>Input frequency range ② is the frequency that must be input within 40 ms after ① was input.</p> <p>When both input frequency ranges ① and ② are satisfied, a broadcast station is judged to be present and autotuning stops.</p>	Area \ Item	Input Frequency Range ①	Input Frequency Range ②	All areas	10.7 MHz ± 50kHz	10.7 MHz ± 12.5kHz	Input																
Area \ Item	Input Frequency Range ①	Input Frequency Range ②																								
All areas	10.7 MHz ± 50kHz	10.7 MHz ± 12.5kHz																								

# DMC 4001

PIN NO.	SYMBOL	FUNCTION	DESCRIPTION	OUTPUT TYPE
18	MONO/NR <sub>2</sub>	Monaural and noise reduction output	<p>In the radio mode, this pin operates as the MONO signal output pin and in the tape mode, this pin operates as the NOISE REDUCTION signal output pin.</p> <p>- Radio mode Each time the <b>MONO</b> key is pressed on the FM and VF bands, the output is inverted. When the device is set to the MONO state by <b>MONO</b> key, the LCD panel "MONO" display lights and high level is output from this pin. On the MW and LW bands, this pin becomes low. When the power is turned on, this pin becomes low.</p> <p>- Tape mode This pin is valid when the diode matrix ENNR<sub>2</sub> switch to be described later is 1. When NOISE REDUCTION NR<sub>2</sub> is selected by pressing the <b>NR</b> key or NOISE REDUCTION function key (selected by diode matrix), high level is output. At this time, the LCD panel "NR<sub>2</sub>" display lights. In the radio monitor and DK ON modes, the "MONO" display is inverted and the MONO/NR<sub>2</sub> pin is made MONO output by pressing the <b>MONO</b> key. When the power is turned on, this pin becomes low.</p>	CMOS pushpull
19	LOUD	LOUD output	<p>LOUDNESS signal output pin.</p> <p>In the radio, tape and CD modes, the output is inverted each time the <b>LOUD</b> key is pressed. When the LOUDNESS state is selected by <b>LOUD</b> key, the LCD panel "LOUD" display lights and high level is output from this pin. When the power is turned on, this pin becomes low.</p>	CMOS pushpull
20	AMS	AMS signal output	<p>Tape mode AMS(AUTO MUSIC SEARCH) control signal output pin.</p> <p>Its output is inverted each time the <b>AMS</b> key is pressed. High level is output while the LCD panel "AMS" display is lit.</p>	CMOS pushpull

# DMC 4001

PIN No.	SYMBOL	FUNCTION	DESCRIPTION	OUTPUT TYPE
21	MTL	Metal output	<p>Tape mode metal signal output pin.</p> <p>Its output is inverted each time the <span style="border: 1px solid black; padding: 2px;">MTL</span> key and METAL function key (selected by diode matrix) is pressed. When the METAL state is selected with these keys, the LCD panel " MTL " display lights and high level is output from this pin.</p> <p>When the power is turned on, this pin becomes low.</p>	CMOS pushpull
22	NR <sub>1</sub>	Noise reduction output	<p>Tape mode noise reduction (NR) signal output pin.</p> <p>When NR<sub>1</sub> is selected by the <span style="border: 1px solid black; padding: 2px;">NR</span> key or NOISE REDUCTION function key (selected by diode matrix), the LCD panel "NR<sub>1</sub>" display lights and high level is output from this pin.</p>	CMOS pushpull
23	POWER	Power output	<p>When the CE pin is high level, the output of this pin is inverted each time the <span style="border: 1px solid black; padding: 2px;">POWER</span> key is pressed.</p> <p>When the power is turned on, low level is output.</p> <p>This pin can be used to turn the set power on and off, etc. See "Application Circuits".</p>	CMOS pushpull
24 25	XO XI	Crystal oscillator	<p>Crystal oscillator connection pin. It connects to a 4.5 MHz crystal oscillator.</p> <p>When the clock function is used, the accuracy of the clock is effected by the oscillation frequency accuracy only.</p> <p>Adjust the oscillation frequency while observing the LCD oscillation waveform and PLL local oscillation frequency.</p>	CMOS (XO) Input(XI)
26 58	GND <sub>2</sub> GND <sub>1</sub>	Ground	<p>Device ground pins.</p> <p>Notice : Always connect pins 26 and 58 to the same potential.</p> <p>GND<sub>1</sub> (pin 58) is analog system ground and.</p> <p>GND<sub>2</sub> (pin 26) is digital system ground.</p>	

# DMC 4001

PIN No.	SYMBOL	FUNCTION	DESCRIPTION	OUTPUT TYPE
27	BEEP	Beep output	<p>Beep output pin when momentary key pressed. A 2.25 kHz and 50% duty square wave is output for approximately 40 ms. This time is equal to the premuting time.</p> <p>When a momentary key is pressed and the state of the LCD panel display or output port is changed (valid key) and at the end of 5 seconds hold during preset memory scan and scan operations, a beep is output.</p> <p>To disable the beep, float (leave open) this pin.</p> <p>The beep output is also used at SK alarm at DK standby.</p>	CMOS pushpull
28 to 39  40 to 55	LCD <sub>27</sub> to LCD <sub>16</sub>  LCD <sub>15</sub> /KS <sub>15</sub> to LCD <sub>0</sub> /KS <sub>0</sub>	LCD segment and key source output	<p>LCD panel segment signal output (pins 28 to 55) and key matrix key source signal output (pins 40 to 55) pins.</p> <p>56-dot display is performed at the LCD panel by matrix with the COM<sub>1</sub> pin(pin 56) and COM<sub>2</sub> pin (pin 57).</p> <p>Since LCD<sub>15</sub> / KS<sub>15</sub>(pin 40) to LCD<sub>0</sub> / KS<sub>0</sub>(pin 55) share the key source signal and LCD segment signal, to use them as key source signals, a reverse current prevention diode is necessary. For the connection method, see "Key Matrix Connection" and "Application Circuits".</p>	CMOS pushpull
56 57	COM <sub>1</sub> COM <sub>2</sub>	LCD common signal output	<p>Common signal output to LCD panel.</p> <p>56-dot display is performed at the LCD panel by matrix with LCD<sub>27</sub>(pin 28) to LCD<sub>0</sub>/KS<sub>0</sub>(pin 55)</p>	CMOS pushpull
59 to 62	K <sub>3</sub> to K <sub>0</sub>	Key return signal input	<p>Key matrix key return signal input pin.</p> <p>Since the key source signal output is shared with the LCD segment signal, do not connect a pull-down resistor to this pin.</p>	CMOS pushpull

PIN No.	SYMBOL	FUNCTION	DESCRIPTION	OUTPUT TYPE																																											
63	SD	SD input	<p>Autotuning SD (Station Detector) signal input pin. When the voltage shown below is applied to this pin during the seek operation, a broadcast station is judged to be present.</p> <table border="1" style="width: 100%; border-collapse: collapse; margin-bottom: 10px;"> <thead> <tr> <th style="width: 10%;">Band</th> <th style="width: 10%;">LOCAL Mode</th> <th style="width: 40%;">SD Voltage</th> <th style="width: 40%;">V<sub>DD</sub> = 5V</th> </tr> </thead> <tbody> <tr> <td rowspan="2" style="text-align: center;">FM</td> <td style="text-align: center;">LOCAL</td> <td style="text-align: center;"><math>\frac{28.5}{64} \times V_{DD} \text{ min}</math></td> <td style="text-align: center;">2.227V</td> </tr> <tr> <td style="text-align: center;">DX</td> <td style="text-align: center;"><math>\frac{12.5}{64} \times V_{DD} \text{ min}</math></td> <td style="text-align: center;">0.977V</td> </tr> <tr> <td rowspan="2" style="text-align: center;">MW</td> <td style="text-align: center;">LOCAL</td> <td style="text-align: center;"><math>\frac{15.5}{64} \times V_{DD} \text{ min}</math></td> <td style="text-align: center;">1.211V</td> </tr> <tr> <td style="text-align: center;">DX</td> <td style="text-align: center;"><math>\frac{12.5}{64} \times V_{DD} \text{ min}</math></td> <td style="text-align: center;">0.977V</td> </tr> </tbody> </table> <p>In the auto preset memory mode, search is performed twice in the LOCAL mode and once in the DX mode. The voltage to determine the presence of a broadcast station at this time is shown below.</p> <table border="1" style="width: 100%; border-collapse: collapse; margin-bottom: 10px;"> <thead> <tr> <th style="width: 10%;">Band</th> <th style="width: 10%;">LOCAL Mode</th> <th style="width: 40%;">SD Voltage</th> <th style="width: 40%;">V<sub>DD</sub> = 5V</th> </tr> </thead> <tbody> <tr> <td rowspan="3" style="text-align: center;">FM</td> <td style="text-align: center;">LOCAL (1st time)</td> <td style="text-align: center;"><math>\frac{44.5}{64} \times V_{DD} \text{ min}</math></td> <td style="text-align: center;">3.447V</td> </tr> <tr> <td style="text-align: center;">LOCAL (2nd time)</td> <td style="text-align: center;"><math>\frac{28.5}{64} \times V_{DD} \text{ min}</math></td> <td style="text-align: center;">2.227V</td> </tr> <tr> <td style="text-align: center;">DX (3rd time)</td> <td style="text-align: center;"><math>\frac{12.5}{64} \times V_{DD} \text{ min}</math></td> <td style="text-align: center;">0.977V</td> </tr> <tr> <td rowspan="2" style="text-align: center;">MW</td> <td style="text-align: center;">LOCAL (1st time)</td> <td style="text-align: center;"><math>\frac{18.5}{64} \times V_{DD} \text{ min}</math></td> <td style="text-align: center;">1.445V</td> </tr> <tr> <td style="text-align: center;">LOCAL (2nd time)</td> <td style="text-align: center;"><math>\frac{15.5}{16} \times V_{DD} \text{ min}</math></td> <td style="text-align: center;">1.211V</td> </tr> <tr> <td style="text-align: center;">LW</td> <td style="text-align: center;">DX (3rd time)</td> <td style="text-align: center;"><math>\frac{12.5}{64} \times V_{DD} \text{ min}</math></td> <td style="text-align: center;">0.977V</td> </tr> </tbody> </table>	Band	LOCAL Mode	SD Voltage	V <sub>DD</sub> = 5V	FM	LOCAL	$\frac{28.5}{64} \times V_{DD} \text{ min}$	2.227V	DX	$\frac{12.5}{64} \times V_{DD} \text{ min}$	0.977V	MW	LOCAL	$\frac{15.5}{64} \times V_{DD} \text{ min}$	1.211V	DX	$\frac{12.5}{64} \times V_{DD} \text{ min}$	0.977V	Band	LOCAL Mode	SD Voltage	V <sub>DD</sub> = 5V	FM	LOCAL (1st time)	$\frac{44.5}{64} \times V_{DD} \text{ min}$	3.447V	LOCAL (2nd time)	$\frac{28.5}{64} \times V_{DD} \text{ min}$	2.227V	DX (3rd time)	$\frac{12.5}{64} \times V_{DD} \text{ min}$	0.977V	MW	LOCAL (1st time)	$\frac{18.5}{64} \times V_{DD} \text{ min}$	1.445V	LOCAL (2nd time)	$\frac{15.5}{16} \times V_{DD} \text{ min}$	1.211V	LW	DX (3rd time)	$\frac{12.5}{64} \times V_{DD} \text{ min}$	0.977V	Input
Band	LOCAL Mode	SD Voltage	V <sub>DD</sub> = 5V																																												
FM	LOCAL	$\frac{28.5}{64} \times V_{DD} \text{ min}$	2.227V																																												
	DX	$\frac{12.5}{64} \times V_{DD} \text{ min}$	0.977V																																												
MW	LOCAL	$\frac{15.5}{64} \times V_{DD} \text{ min}$	1.211V																																												
	DX	$\frac{12.5}{64} \times V_{DD} \text{ min}$	0.977V																																												
Band	LOCAL Mode	SD Voltage	V <sub>DD</sub> = 5V																																												
FM	LOCAL (1st time)	$\frac{44.5}{64} \times V_{DD} \text{ min}$	3.447V																																												
	LOCAL (2nd time)	$\frac{28.5}{64} \times V_{DD} \text{ min}$	2.227V																																												
	DX (3rd time)	$\frac{12.5}{64} \times V_{DD} \text{ min}$	0.977V																																												
MW	LOCAL (1st time)	$\frac{18.5}{64} \times V_{DD} \text{ min}$	1.445V																																												
	LOCAL (2nd time)	$\frac{15.5}{16} \times V_{DD} \text{ min}$	1.211V																																												
LW	DX (3rd time)	$\frac{12.5}{64} \times V_{DD} \text{ min}$	0.977V																																												
64	ST	Stereo signal input	<p>Radio mode "ST" (STEREO) display input pin. When low level is input to this pin, the LCD panel "ST" display lights. This pin is valid only on the FM and VF bands. In the MONO mode, "ST" is not displayed.</p>	Input																																											

## 2. KEY MATRIX

### 2.1 KEY MATRIX LAYOUT

Output Pin \ Input Pin	K <sub>3</sub> (59)	K <sub>2</sub> (60)	K <sub>1</sub> (61)	K <sub>0</sub> (62)
LCD <sub>15</sub> / KS <sub>15</sub> (40)	M1 (TP1)	M2 (TP2)	M3 (TP3)	M4
LCD <sub>14</sub> / KS <sub>14</sub> (41)	M5	M6	VF	VF
LCD <sub>13</sub> / KS <sub>13</sub> (42)	SEEK DWN	SEEK UP	SCAN DWN	SCAN UP
LCD <sub>12</sub> / KS <sub>12</sub> (43)	BAND	—	—	—
LCD <sub>11</sub> / KS <sub>11</sub> (44)	ME(DISP)	MAN DWN	MAN UP	PSCAN AMEMO
LCD <sub>10</sub> / KS <sub>10</sub> (45)	LOUD	LOC(TP4)	MONO(TP5)	—
LCD <sub>9</sub> / KS <sub>9</sub> (46)	AMS	NR	MTL	RDMONI
LCD <sub>8</sub> / KS <sub>8</sub> (47)	—	—	—	DISP
LCD <sub>7</sub> / KS <sub>7</sub> (48)	CD SET	TP SET	RD SET	POWER
LCD <sub>6</sub> / KS <sub>6</sub> (49)	SK	DK	FF	RL
LCD <sub>5</sub> / KS <sub>5</sub> (50)	AUTO600	MUTESEL	AUTOLOC	ENNR2
LCD <sub>4</sub> / KS <sub>4</sub> (51)	KAMS	KNR	KMTL	ENTPK
LCD <sub>3</sub> / KS <sub>3</sub> (52)	NOCLK	CLK DISP	FLASH	DISMEMO
LCD <sub>2</sub> / KS <sub>2</sub> (53)	ENFMIF	DISAMIF	PRIO2	PRIO1
LCD <sub>1</sub> / KS <sub>1</sub> (54)	DISFM3	ENMW2	DISLW	M2S
LCD <sub>0</sub> / KS <sub>0</sub> (55)	AREA3	AREA2	AREA1	PDCN

( ) : Pin No

### 2.2 SWITCH CONNECTION

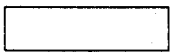

: Momentary switch

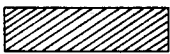

: Alternate or transistor switch



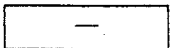

: Diode matrix

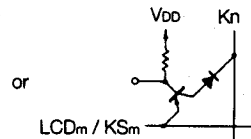
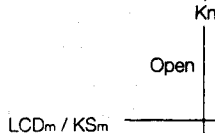
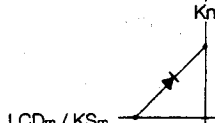
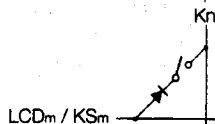
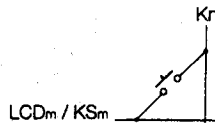

: Open



## 2.3 KEY MATRIX CONNECTION

-  Momentary switch
-  Alternate or transistor switch
-  Diode matrix

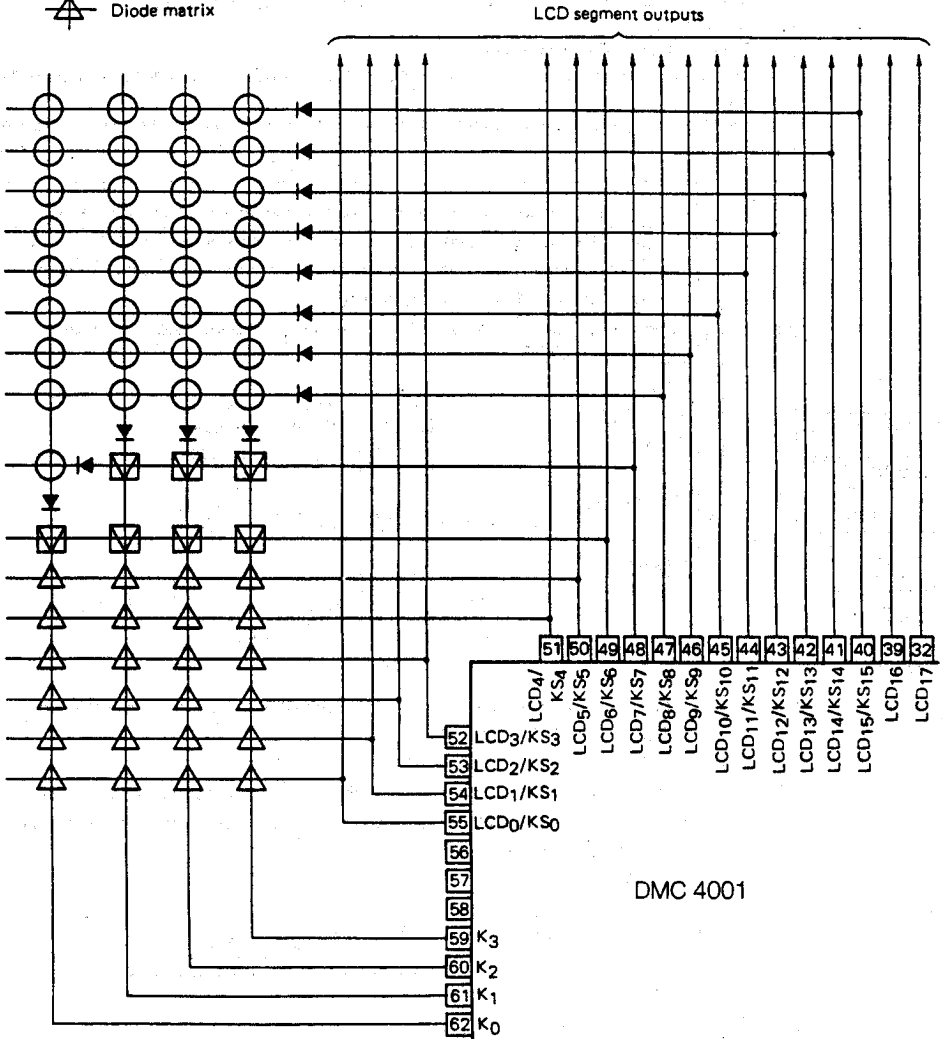



## 2.4 DESCRIPTION OF KEY MATRIX

### 2.4.1 Momentary Switch

Symbol	Function																				
<div style="display: flex; flex-direction: column; gap: 5px;"> <div style="border: 1px solid black; padding: 2px; width: 100px; text-align: center;">M1(TP1)</div> <div style="border: 1px solid black; padding: 2px; width: 100px; text-align: center;">M2(TP2)</div> <div style="border: 1px solid black; padding: 2px; width: 100px; text-align: center;">M3(TP3)</div> <div style="border: 1px solid black; padding: 2px; width: 100px; text-align: center;">M4</div> <div style="border: 1px solid black; padding: 2px; width: 100px; text-align: center;">M5</div> <div style="border: 1px solid black; padding: 2px; width: 100px; text-align: center;">M6</div> </div>	<p>In the radio mode, these keys are used to call and write preset memory. In the tape mode, these are used as tape function keys by initialized diode ( ENTPK, KAMS, KNR, KMTL ).</p> <p>- Radio mode</p> <p>Preset memory call and write keys.</p> <p>One key can memorize the FM1, FM2, FM3, VF, MW1, MW2 and LW bands independently (max. 6 bands).</p> <p>The following operations are performed according to the state of M2S of the initialized diodes :</p> <table border="1" style="width: 100%; border-collapse: collapse;"> <thead> <tr> <th style="width: 10%; text-align: center;">M2S</th> <th style="text-align: center;">Description</th> </tr> </thead> <tbody> <tr> <td style="text-align: center; vertical-align: middle;">W</td> <td> <p>The device is placed into the 5 seconds preset memory write mode by pressing the <b>ME</b> key during frequency display. When one of the keys <b>M1 (TP1)</b> to <b>M6</b> is pressed during this 5 seconds, the current receiving frequency is written to the preset memory corresponding to the pressed key.</p> <p>When the <b>ME</b> key is held down, writing is not performed. During writing, radio muting is not output.</p> <p>Example</p> </td> </tr> <tr> <td style="text-align: center; vertical-align: middle;">R</td> <td> <p>Example</p> </td> </tr> <tr> <td style="text-align: center; vertical-align: middle;">I</td> <td> </td> </tr> <tr> <td style="text-align: center; vertical-align: middle;">E</td> <td> <p>When the same preset memory key is pressed while the current preset memory contents are being received, the same operation is performed.</p> </td> </tr> <tr> <td style="text-align: center; vertical-align: middle;">O</td> <td> <p>In the radio mode, when the device is in the memory unwritable state, when one of the <b>M1 (TP1)</b> to <b>M6</b> keys is pressed, the preset memory contents corresponding to the pressed key can be called.</p> <p>Example</p> </td> </tr> <tr> <td style="text-align: center; vertical-align: middle;">C</td> <td> </td> </tr> <tr> <td style="text-align: center; vertical-align: middle;">A</td> <td> <p>When the same preset memory key is pressed while the current preset memory contents are being received, no operation is performed. However, if the clock is being displayed, BEEP is output and the display switches to frequency display. Radio muting is not output.</p> </td> </tr> <tr> <td style="text-align: center; vertical-align: middle;">L</td> <td></td> </tr> <tr> <td style="text-align: center; vertical-align: middle;">L</td> <td></td> </tr> </tbody> </table>	M2S	Description	W	<p>The device is placed into the 5 seconds preset memory write mode by pressing the <b>ME</b> key during frequency display. When one of the keys <b>M1 (TP1)</b> to <b>M6</b> is pressed during this 5 seconds, the current receiving frequency is written to the preset memory corresponding to the pressed key.</p> <p>When the <b>ME</b> key is held down, writing is not performed. During writing, radio muting is not output.</p> <p>Example</p>	R	<p>Example</p>	I		E	<p>When the same preset memory key is pressed while the current preset memory contents are being received, the same operation is performed.</p>	O	<p>In the radio mode, when the device is in the memory unwritable state, when one of the <b>M1 (TP1)</b> to <b>M6</b> keys is pressed, the preset memory contents corresponding to the pressed key can be called.</p> <p>Example</p>	C		A	<p>When the same preset memory key is pressed while the current preset memory contents are being received, no operation is performed. However, if the clock is being displayed, BEEP is output and the display switches to frequency display. Radio muting is not output.</p>	L		L	
M2S	Description																				
W	<p>The device is placed into the 5 seconds preset memory write mode by pressing the <b>ME</b> key during frequency display. When one of the keys <b>M1 (TP1)</b> to <b>M6</b> is pressed during this 5 seconds, the current receiving frequency is written to the preset memory corresponding to the pressed key.</p> <p>When the <b>ME</b> key is held down, writing is not performed. During writing, radio muting is not output.</p> <p>Example</p>																				
R	<p>Example</p>																				
I																					
E	<p>When the same preset memory key is pressed while the current preset memory contents are being received, the same operation is performed.</p>																				
O	<p>In the radio mode, when the device is in the memory unwritable state, when one of the <b>M1 (TP1)</b> to <b>M6</b> keys is pressed, the preset memory contents corresponding to the pressed key can be called.</p> <p>Example</p>																				
C																					
A	<p>When the same preset memory key is pressed while the current preset memory contents are being received, no operation is performed. However, if the clock is being displayed, BEEP is output and the display switches to frequency display. Radio muting is not output.</p>																				
L																					
L																					

# DMC 4001

Symbol	Function						
<div style="border: 1px solid black; padding: 2px; margin-bottom: 2px;">M1 (TP1)</div> <div style="border: 1px solid black; padding: 2px; margin-bottom: 2px;">M2 (TP2)</div> <div style="border: 1px solid black; padding: 2px; margin-bottom: 2px;">M3 (TP3)</div> <div style="border: 1px solid black; padding: 2px; margin-bottom: 2px;">M4</div> <div style="border: 1px solid black; padding: 2px; margin-bottom: 2px;">M5</div> <div style="border: 1px solid black; padding: 2px; margin-bottom: 2px;">M6</div>	<table border="1" style="width: 100%; border-collapse: collapse;"> <thead> <tr> <th style="width: 10%; text-align: center;">M2S</th> <th style="width: 90%;">Description</th> </tr> </thead> <tbody> <tr> <td style="text-align: center; vertical-align: middle;">W R I T E</td> <td> <p>When one of the key <span style="border: 1px solid black; padding: 2px;">M1 (TP1)</span> to <span style="border: 1px solid black; padding: 2px;">M6</span> is pressed for more than 2 seconds, the preset memory corresponding to the pressed key is written. At the end of writing to the preset memory, radio muting is output as acknowledgment.</p> <p>When the same preset memory key is pressed while the current preset memory contents are being received, nothing is performed. However, if the clock is being displayed, BEEP is output when the key is released or after 2 seconds and the display switches to frequency display. At this time, radio muting is not output. If a key is pressed during the seek operation, the call operation is immediately performed (2 second count is ignored).</p> </td> </tr> <tr> <td style="text-align: center; vertical-align: middle;">C A L L</td> <td> <p>When a <span style="border: 1px solid black; padding: 2px;">M1 (TP1)</span> to <span style="border: 1px solid black; padding: 2px;">M6</span> key is pressed and released within 2 seconds, the preset memory contents at the time the key was released are called.</p> <p>When the same preset memory key is pressed while the current preset memory contents are being received, nothing is performed. However, if the clock is being displayed, Beep is output and the display switches to frequency display. Radio muting is not output. If a key is pressed during the seek operation, the call operation is immediately performed.</p> </td> </tr> </tbody> </table>	M2S	Description	W R I T E	<p>When one of the key <span style="border: 1px solid black; padding: 2px;">M1 (TP1)</span> to <span style="border: 1px solid black; padding: 2px;">M6</span> is pressed for more than 2 seconds, the preset memory corresponding to the pressed key is written. At the end of writing to the preset memory, radio muting is output as acknowledgment.</p> <p>When the same preset memory key is pressed while the current preset memory contents are being received, nothing is performed. However, if the clock is being displayed, BEEP is output when the key is released or after 2 seconds and the display switches to frequency display. At this time, radio muting is not output. If a key is pressed during the seek operation, the call operation is immediately performed (2 second count is ignored).</p>	C A L L	<p>When a <span style="border: 1px solid black; padding: 2px;">M1 (TP1)</span> to <span style="border: 1px solid black; padding: 2px;">M6</span> key is pressed and released within 2 seconds, the preset memory contents at the time the key was released are called.</p> <p>When the same preset memory key is pressed while the current preset memory contents are being received, nothing is performed. However, if the clock is being displayed, Beep is output and the display switches to frequency display. Radio muting is not output. If a key is pressed during the seek operation, the call operation is immediately performed.</p>
M2S	Description						
W R I T E	<p>When one of the key <span style="border: 1px solid black; padding: 2px;">M1 (TP1)</span> to <span style="border: 1px solid black; padding: 2px;">M6</span> is pressed for more than 2 seconds, the preset memory corresponding to the pressed key is written. At the end of writing to the preset memory, radio muting is output as acknowledgment.</p> <p>When the same preset memory key is pressed while the current preset memory contents are being received, nothing is performed. However, if the clock is being displayed, BEEP is output when the key is released or after 2 seconds and the display switches to frequency display. At this time, radio muting is not output. If a key is pressed during the seek operation, the call operation is immediately performed (2 second count is ignored).</p>						
C A L L	<p>When a <span style="border: 1px solid black; padding: 2px;">M1 (TP1)</span> to <span style="border: 1px solid black; padding: 2px;">M6</span> key is pressed and released within 2 seconds, the preset memory contents at the time the key was released are called.</p> <p>When the same preset memory key is pressed while the current preset memory contents are being received, nothing is performed. However, if the clock is being displayed, Beep is output and the display switches to frequency display. Radio muting is not output. If a key is pressed during the seek operation, the call operation is immediately performed.</p>						

# DMC 4001

Symbol	Function																
<div style="border: 1px solid black; padding: 2px; margin-bottom: 5px; width: fit-content;">M1 (TP1)</div> <div style="border: 1px solid black; padding: 2px; margin-bottom: 5px; width: fit-content;">M2 (TP2)</div> <div style="border: 1px solid black; padding: 2px; margin-bottom: 5px; width: fit-content;">M3 (TP3)</div> <div style="border: 1px solid black; padding: 2px; margin-bottom: 5px; width: fit-content;">M4</div> <div style="border: 1px solid black; padding: 2px; margin-bottom: 5px; width: fit-content;">M5</div> <div style="border: 1px solid black; padding: 2px; margin-bottom: 5px; width: fit-content;">M6</div>	<p>When the power is turned on, the frequency shown below are written to M1 to M6 to facilitate set adjustment.</p>																
	<table border="1" style="border-collapse: collapse; width: 100%;"> <tr> <th style="width: 15%;">Area</th> <th style="width: 15%;">Memory Band</th> <th style="width: 12.5%;">M1</th> <th style="width: 12.5%;">M2</th> <th style="width: 12.5%;">M3</th> <th style="width: 12.5%;">M4</th> <th style="width: 12.5%;">M5</th> <th style="width: 12.5%;">M6</th> </tr> </table>		Area	Memory Band	M1	M2	M3	M4	M5	M6							
	Area	Memory Band	M1	M2	M3	M4	M5	M6									
	Europe 1 Europe 2		FM1	87.5	87.7	92.3	96.3	105.9	87.5								
			MW1	522	603	954	1386	522	522								
			MW2	522	621	1098	1530	522	522								
	U. S. A 1 U. S. A 2 U. S. A 3		FM1	87.5	87.9	97.1	105.1	87.5	87.5								
			MW1	530	620	1010	1490	530	530								
			FM1	87.5	87.9	97.1	105.1	87.5	87.5								
	Australia, Middle East		MW1	531	612	963	1395	531	531								
			FM1	87.5	87.9	97.1	105.1	87.5	87.5								
	Japan		MW1	522	603	954	1386	522	522								
FM1			87.5	87.9	97.1	105.1	87.5	87.5									
Central and South America		MW1	520	565	760	1000	1400	520									
		FM1	87.5	87.9	97.1	105.1	87.5	87.5									

The lowest frequency of each area is M1 to M6 of the FM2, FM3, VF and MW2 bands of other than Europe 1 and 2.

- Tape mode

These keys can be used as tape function keys by means of initialized diode matrix switches ENTPK, KAMS and KMTL.

For the keys that can be used, see the diode matrix. For a description of each key operation, see the

AMS , NR and MTL key items.

VF(traffic information) broadcast station search key. Its operation is described below.

When this key is pressed in the radio mode (FM, MW or LW band), the LCD panel "VF" display and Band2 pin output are inverted.

When this key is pressed, the VF band is selected and 375 to 500 ms later, whether or not there is a broadcast station(IF count and SD check) and SK signal are detected. If no VF broadcast station is judged not to be present (The presence of a VF broadcast station is determined by the presence of an IF count , SD signal and SK signal),autotuning starts from that frequency.

When the first broadcast station is detected, that frequency is held until the autotuning key is pressed thereafter, even when there is no SK signal.

When the IF count and SD check are judged to be present, the autotuning operation is the same as normal autotuning, except that the SK signal is detected after 375 to 500 ms.

Autotuning(seek up) is performed automatically only when VF band is selected by VF key for the first time. Autotuning is not performed automatically even if another tuning key (other than autotuning) is pressed.

Symbol	Function
<div style="border: 1px solid black; padding: 2px; width: fit-content; margin: 0 auto;">VF</div>	<p>To reset the VF band, press the <span style="border: 1px solid black; padding: 2px;">VF</span> key or <span style="border: 1px solid black; padding: 2px;">BAND</span> key.</p> <p>The VF band has 6 independent memories. The last channel is also independent.</p> <p>When the device is set to the tape or CD mode by TPSET or CDSET switch while on the VF band, it switches to the DK standby mode. The device also switches to the DK standby mode when the <span style="border: 1px solid black; padding: 2px;">VF</span> key is pressed in the tape or CD mode. In the DK standby mode, all the keys, other than the <span style="border: 1px solid black; padding: 2px;">BAND</span> key, are valid. When the DK switch is set to ON in the DK standby mode, the device switches to the DK ON mode. In the DK ON mode, radio muting (<u>RDMUTE</u> pin) is turned off and audio muting (<u>AMUTE</u> pin) is turned on.</p> <p>When both the SD and SK signals or one of signals are lost during VF band reception(including TAPE or CD DK standby mode), BEEP is output.</p> <p>The SD and SK signals are checked 512 times once every 30 ms and if there are no SD and SK signals for 256 times or more, BEEP is output.</p> <p>For BEEP, 120 ms ON and 120 ms OFF are output 5 times, respectively.</p>
<div style="border: 1px solid black; padding: 2px; width: fit-content; margin: 0 auto;">PSCAN AMEMO</div>	<p>Preset memory scan and auto store memory key.</p> <p>The auto store memory function is enabled when initialized diode DISAMEMO is 0.</p> <p>When the auto store memory is used (DISAMEMO = 0), when this key is pressed and released within 2 seconds, preset memory scanning is performed. When this key is held down for more than 2 seconds, operation switches to auto store memory operation.</p> <p>When the auto store memory is not used (DISAMEMO = 1), the preset memory scanning operation starts the moment the button is pressed.</p> <p>The preset memory scan and auto store memory operations are described below.</p> <p>(1) Preset memory scan operation</p> <p>The preset memory contents are called automatically every 5 seconds.</p> <p>If other than the current preset memory is being received, the preset memories are called from M1, and if a present memory is being received the preset memories are called from the next preset memory (for instance, from M4 if M3 is being received) sequentially every 5 seconds.</p> <p>This operation is shown below.</p> <p>Example When FM1 band being received.</p> <p style="margin-left: 40px;">FM1</p> <div style="margin-left: 40px; border: 1px solid black; padding: 5px; display: inline-block;"> <p>M1 → M2 → M3 → M4 → M5 → M6</p> </div> <p style="margin-left: 40px;">Other than preset memory being received on FM1 band</p> <p style="margin-left: 100px;">M3 being received on FM1 band.</p> <p>This operation is the same for the MW bands (MW1, MW2) and LW band.</p>

Symbol	Function						
	<p>When the next preset memory is called at the end of 5 second hold, BEEP is output.</p> <p>During 5 second hold, the preset memory number display flashes at 1 Hz (duty 50%). The "ch" display does not flash.</p> <p>To stop at that preset memory during 5 second hold, press this key again, or press the same preset memory key as the preset memory being received. Writing of preset memory (for example, writing to M5 during M1 hold) is also possible, but the preset memory scan operation ends when the preset memory was written.</p> <p>The preset memory write operation during 5 second hold is described below.</p>						
	<table border="1" style="width: 100%; border-collapse: collapse;"> <thead> <tr> <th style="width: 10%; text-align: center;">M2S</th> <th style="text-align: center;">Description</th> </tr> </thead> <tbody> <tr> <td style="text-align: center; vertical-align: top;">0</td> <td> <p>When the <span style="border: 1px solid black; padding: 2px;">ME</span> key is pressed, the device enters the 5 second memory write mode. Writing is performed by pressing a <span style="border: 1px solid black; padding: 2px;">M1 (TP1)</span> to <span style="border: 1px solid black; padding: 2px;">M6</span> key in the memory writable mode. At the end of writing, auto preset memory scanning stops. In the memory writable mode, the "ch" display flashes. If no operation is performed within 5 seconds, the next preset memory channel is called and auto preset scanning continues.</p> <p>If the <span style="border: 1px solid black; padding: 2px;">ME</span> key is pressed again in the memory writable mode, the memory writable mode is canceled and the next channel is called 5 seconds after the key was pressed.</p> </td> </tr> <tr> <td style="text-align: center; vertical-align: top;">1</td> <td> <p>When a <span style="border: 1px solid black; padding: 2px;">M1 (TP1)</span> to <span style="border: 1px solid black; padding: 2px;">M6</span> key is pressed for more than 2 seconds, the frequency currently being received is written to the preset memory corresponding to the pressed key.</p> <p>Auto preset scanning ends when the frequency was written to the preset memory (2 seconds after the key was pressed).</p> </td> </tr> </tbody> </table>	M2S	Description	0	<p>When the <span style="border: 1px solid black; padding: 2px;">ME</span> key is pressed, the device enters the 5 second memory write mode. Writing is performed by pressing a <span style="border: 1px solid black; padding: 2px;">M1 (TP1)</span> to <span style="border: 1px solid black; padding: 2px;">M6</span> key in the memory writable mode. At the end of writing, auto preset memory scanning stops. In the memory writable mode, the "ch" display flashes. If no operation is performed within 5 seconds, the next preset memory channel is called and auto preset scanning continues.</p> <p>If the <span style="border: 1px solid black; padding: 2px;">ME</span> key is pressed again in the memory writable mode, the memory writable mode is canceled and the next channel is called 5 seconds after the key was pressed.</p>	1	<p>When a <span style="border: 1px solid black; padding: 2px;">M1 (TP1)</span> to <span style="border: 1px solid black; padding: 2px;">M6</span> key is pressed for more than 2 seconds, the frequency currently being received is written to the preset memory corresponding to the pressed key.</p> <p>Auto preset scanning ends when the frequency was written to the preset memory (2 seconds after the key was pressed).</p>
M2S	Description						
0	<p>When the <span style="border: 1px solid black; padding: 2px;">ME</span> key is pressed, the device enters the 5 second memory write mode. Writing is performed by pressing a <span style="border: 1px solid black; padding: 2px;">M1 (TP1)</span> to <span style="border: 1px solid black; padding: 2px;">M6</span> key in the memory writable mode. At the end of writing, auto preset memory scanning stops. In the memory writable mode, the "ch" display flashes. If no operation is performed within 5 seconds, the next preset memory channel is called and auto preset scanning continues.</p> <p>If the <span style="border: 1px solid black; padding: 2px;">ME</span> key is pressed again in the memory writable mode, the memory writable mode is canceled and the next channel is called 5 seconds after the key was pressed.</p>						
1	<p>When a <span style="border: 1px solid black; padding: 2px;">M1 (TP1)</span> to <span style="border: 1px solid black; padding: 2px;">M6</span> key is pressed for more than 2 seconds, the frequency currently being received is written to the preset memory corresponding to the pressed key.</p> <p>Auto preset scanning ends when the frequency was written to the preset memory (2 seconds after the key was pressed).</p>						
<div style="border: 1px solid black; padding: 2px; width: fit-content; margin: 0 auto;">PSCAN AMEMO</div>	<p>When one of the following keys is pressed during preset memory scanning, preset memory scanning stops and the operation of the pressed key is performed.</p> <div style="display: flex; justify-content: space-around; margin-bottom: 10px;"> <div style="border: 1px solid black; padding: 2px 10px;">MAN UP</div> <div style="border: 1px solid black; padding: 2px 10px;">MAN DWN</div> <div style="border: 1px solid black; padding: 2px 10px;">SEEK UP</div> <div style="border: 1px solid black; padding: 2px 10px;">SEEK DWN</div> </div> <div style="display: flex; justify-content: space-around; margin-bottom: 10px;"> <div style="border: 1px solid black; padding: 2px 10px;">SCAN UP</div> <div style="border: 1px solid black; padding: 2px 10px;">SCAN DWN</div> <div style="border: 1px solid black; padding: 2px 10px;">VF</div> </div> <p>Memory call key other than memory being received (held)</p> <p>Band switching key</p> <p>When one of the following keys is pressed during preset memory scanning, after the operation of the pressed key is performed, preset memory scanning is continued.</p> <div style="display: flex; justify-content: space-around; margin-top: 10px;"> <div style="border: 1px solid black; padding: 2px 10px;">LOUD</div> <div style="border: 1px solid black; padding: 2px 10px;">LOC (TP4)</div> <div style="border: 1px solid black; padding: 2px 10px;">MONO (TP5)</div> </div>						

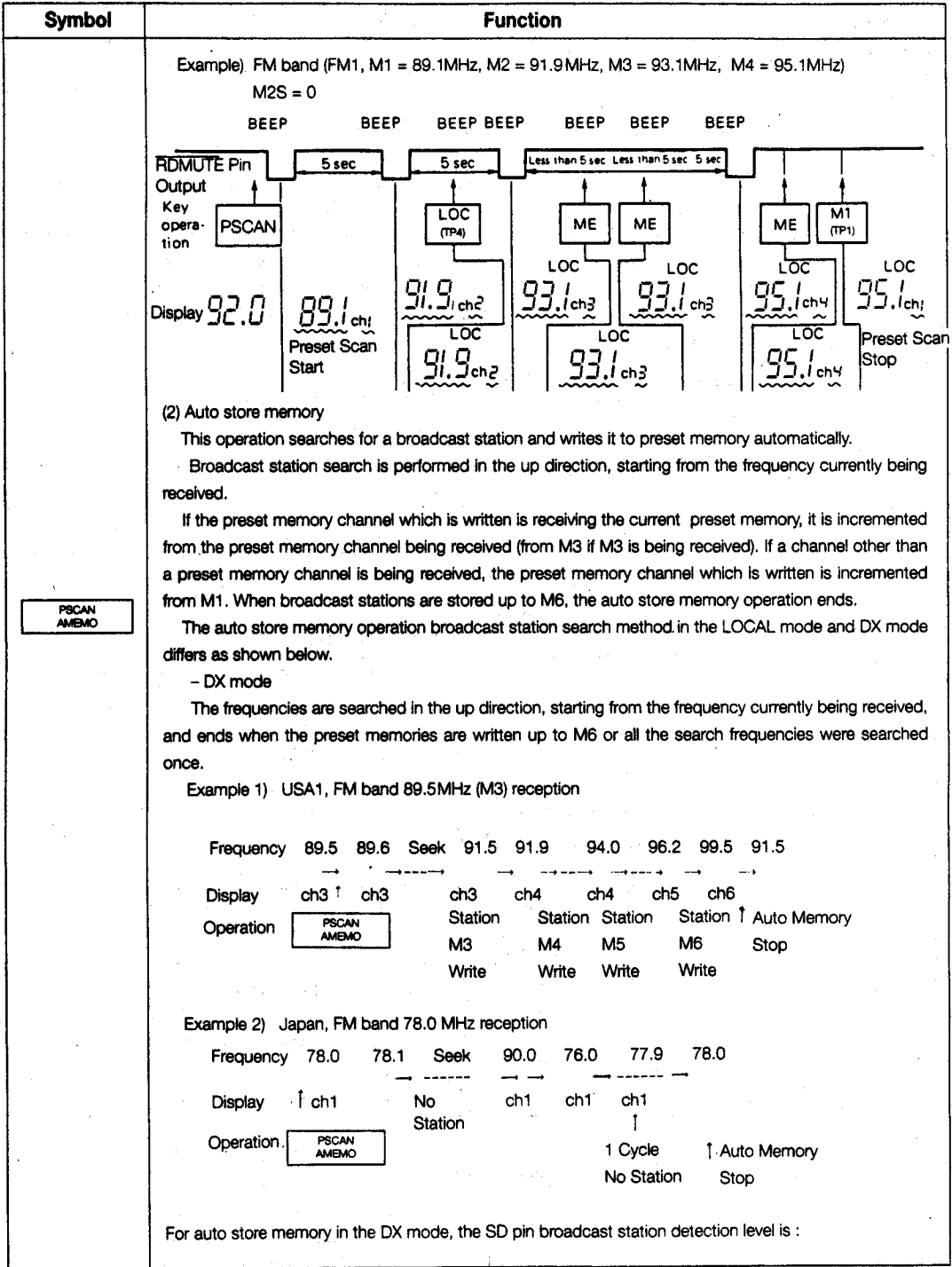

PSCAN  
AMEMO

Symbol	Function																																																																																											
	<table border="1" style="margin: auto;"> <thead> <tr> <th>Band</th> <th colspan="2">Lowest Voltage to Determine the Presence of Station</th> </tr> </thead> <tbody> <tr> <td>FM MW LW VF</td> <td><math>\frac{12.5}{64} \times V_{DD}</math></td> <td>0.977 V at <math>V_{DD} = 5V</math></td> </tr> </tbody> </table>	Band	Lowest Voltage to Determine the Presence of Station		FM MW LW VF	$\frac{12.5}{64} \times V_{DD}$	0.977 V at $V_{DD} = 5V$																																																																																					
Band	Lowest Voltage to Determine the Presence of Station																																																																																											
FM MW LW VF	$\frac{12.5}{64} \times V_{DD}$	0.977 V at $V_{DD} = 5V$																																																																																										
	<p>- LOCAL mode</p> <p>The frequencies are searched in the up direction, starting from the frequency currently being received. In the LOCAL mode, the SD detection level is changed and the frequencies are searched twice. In the DX mode, the frequencies are searched once. When the preset memories are written up to M6 during this time or at the end of 3 searches, the auto store memory operation ends.</p> <p>Example) Europe, AM band 1422 kHz reception</p> <div style="display: flex; align-items: flex-start;"> <div style="margin-right: 20px;"> <p>Frequency</p> <p>Display</p> <p>Operation</p> </div> <div> <table style="width: 100%; border-collapse: collapse;"> <tr> <td style="text-align: center;">1422</td> <td style="text-align: center;">1531</td> <td style="text-align: center;">Seek</td> <td style="text-align: center;">1611</td> <td style="text-align: center;">1620</td> <td style="text-align: center;">522</td> <td style="text-align: center;">1413</td> </tr> <tr> <td style="text-align: center;">↑</td> <td></td> <td></td> <td></td> <td></td> <td></td> <td></td> </tr> <tr> <td style="text-align: center;">ch1</td> <td></td> <td></td> <td style="text-align: center;">ch1</td> <td style="text-align: center;">ch2</td> <td style="text-align: center;">ch2</td> <td style="text-align: center;">ch2</td> </tr> <tr> <td colspan="3" style="text-align: center;"> <div style="border: 1px solid black; padding: 2px; display: inline-block;">PSCAN AMEMO</div> </td> <td colspan="4" style="text-align: center;">                     Station M1 Write                 </td> </tr> <tr> <td colspan="7" style="text-align: center;">(LOCAL, 1st Time)</td> </tr> <tr> <td style="text-align: center;">1422</td> <td></td> <td></td> <td style="text-align: center;">1620</td> <td style="text-align: center;">522</td> <td></td> <td style="text-align: center;">1413</td> </tr> <tr> <td style="text-align: center;">ch2</td> <td></td> <td></td> <td style="text-align: center;">ch2</td> <td style="text-align: center;">ch2</td> <td></td> <td></td> </tr> <tr> <td colspan="7" style="text-align: center;">(LOCAL, 2nd Time)</td> </tr> <tr> <td style="text-align: center;">1422</td> <td></td> <td></td> <td style="text-align: center;">1620</td> <td style="text-align: center;">522</td> <td style="text-align: center;">695</td> <td style="text-align: center;">1413</td> </tr> <tr> <td style="text-align: center;">ch2</td> <td></td> <td></td> <td style="text-align: center;">ch2</td> <td style="text-align: center;">ch2</td> <td style="text-align: center;">ch2</td> <td style="text-align: center;">ch3</td> </tr> <tr> <td colspan="6" style="text-align: center;">(DX 1st Time)</td> <td style="text-align: center;">                     Station M2 Write                 </td> </tr> <tr> <td style="text-align: center;">1422</td> <td colspan="6"></td> </tr> <tr> <td colspan="7" style="text-align: center;">Auto Memory Stop</td> </tr> </table> </div> </div>	1422	1531	Seek	1611	1620	522	1413	↑							ch1			ch1	ch2	ch2	ch2	<div style="border: 1px solid black; padding: 2px; display: inline-block;">PSCAN AMEMO</div>			Station M1 Write				(LOCAL, 1st Time)							1422			1620	522		1413	ch2			ch2	ch2			(LOCAL, 2nd Time)							1422			1620	522	695	1413	ch2			ch2	ch2	ch2	ch3	(DX 1st Time)						Station M2 Write	1422							Auto Memory Stop						
1422	1531	Seek	1611	1620	522	1413																																																																																						
↑																																																																																												
ch1			ch1	ch2	ch2	ch2																																																																																						
<div style="border: 1px solid black; padding: 2px; display: inline-block;">PSCAN AMEMO</div>			Station M1 Write																																																																																									
(LOCAL, 1st Time)																																																																																												
1422			1620	522		1413																																																																																						
ch2			ch2	ch2																																																																																								
(LOCAL, 2nd Time)																																																																																												
1422			1620	522	695	1413																																																																																						
ch2			ch2	ch2	ch2	ch3																																																																																						
(DX 1st Time)						Station M2 Write																																																																																						
1422																																																																																												
Auto Memory Stop																																																																																												
<div style="border: 1px solid black; padding: 2px; display: inline-block;">PSCAN AMEMO</div>																																																																																												
	<p>The SD detection level for LOCAL mode auto store memory is :</p> <table border="1" style="margin: auto;"> <thead> <tr> <th>Band</th> <th>Mode</th> <th colspan="2">Lowest Voltage judged a Broadcast Station</th> </tr> </thead> <tbody> <tr> <td rowspan="3">FM VF</td> <td>LOCAL 1st time</td> <td><math>\frac{44.5}{64} \times V_{DD}</math></td> <td>3.447V at <math>V_{DD} = 5V</math></td> </tr> <tr> <td>LOCAL 2nd time</td> <td><math>\frac{28.5}{64} \times V_{DD}</math></td> <td>2.227V at <math>V_{DD} = 5V</math></td> </tr> <tr> <td>DX 1st time</td> <td><math>\frac{12.5}{64} \times V_{DD}</math></td> <td>0.977V at <math>V_{DD} = 5V</math></td> </tr> <tr> <td rowspan="3">MW LW</td> <td>LOCAL 1st time</td> <td><math>\frac{18.5}{64} \times V_{DD}</math></td> <td>1.445V at <math>V_{DD} = 5V</math></td> </tr> <tr> <td>LOCAL 2nd time</td> <td><math>\frac{15.5}{64} \times V_{DD}</math></td> <td>1.211V at <math>V_{DD} = 5V</math></td> </tr> <tr> <td>DX 1st time</td> <td><math>\frac{12.5}{64} \times V_{DD}</math></td> <td>0.997V at <math>V_{DD} = 5V</math></td> </tr> </tbody> </table>	Band	Mode	Lowest Voltage judged a Broadcast Station		FM VF	LOCAL 1st time	$\frac{44.5}{64} \times V_{DD}$	3.447V at $V_{DD} = 5V$	LOCAL 2nd time	$\frac{28.5}{64} \times V_{DD}$	2.227V at $V_{DD} = 5V$	DX 1st time	$\frac{12.5}{64} \times V_{DD}$	0.977V at $V_{DD} = 5V$	MW LW	LOCAL 1st time	$\frac{18.5}{64} \times V_{DD}$	1.445V at $V_{DD} = 5V$	LOCAL 2nd time	$\frac{15.5}{64} \times V_{DD}$	1.211V at $V_{DD} = 5V$	DX 1st time	$\frac{12.5}{64} \times V_{DD}$	0.997V at $V_{DD} = 5V$																																																																			
Band	Mode	Lowest Voltage judged a Broadcast Station																																																																																										
FM VF	LOCAL 1st time	$\frac{44.5}{64} \times V_{DD}$	3.447V at $V_{DD} = 5V$																																																																																									
	LOCAL 2nd time	$\frac{28.5}{64} \times V_{DD}$	2.227V at $V_{DD} = 5V$																																																																																									
	DX 1st time	$\frac{12.5}{64} \times V_{DD}$	0.977V at $V_{DD} = 5V$																																																																																									
MW LW	LOCAL 1st time	$\frac{18.5}{64} \times V_{DD}$	1.445V at $V_{DD} = 5V$																																																																																									
	LOCAL 2nd time	$\frac{15.5}{64} \times V_{DD}$	1.211V at $V_{DD} = 5V$																																																																																									
	DX 1st time	$\frac{12.5}{64} \times V_{DD}$	0.997V at $V_{DD} = 5V$																																																																																									

Symbol	Function				
<div style="border: 1px solid black; width: fit-content; padding: 2px; margin-bottom: 5px;">PSCAN AMEMO</div>	<p>When the auto local function is used, each time the <span style="border: 1px solid black; padding: 2px;">PSCAN AMEMO</span> key is pressed, the local mode is switched as shown below.</p> <p style="text-align: center;">LOCAL1 → LOCAL2 → DX → auto memory stop</p> <p>When the local mode is switched, the auto memory operation is repeated from the frequency at which is started. When the auto memory operation was stopped, if even one broadcast station was written, operation shifts automatically from the preset memory when the auto memory operation started to preset scan operation.</p>				
<div style="border: 1px solid black; width: fit-content; padding: 2px; margin-bottom: 5px;">SEEK UP</div> <div style="border: 1px solid black; width: fit-content; padding: 2px;">SEEK DWN</div>	<p>Autotuning (seek operation) key.</p> <p>The frequencies are incremented ( <span style="border: 1px solid black; padding: 2px;">SEEK UP</span> key) or decremented ( <span style="border: 1px solid black; padding: 2px;">SEEK DWN</span> key) in 1 channel space and whether or not there is a broadcast station (IF count and SD signal) is detected at each receiving frequency and when there is a broadcast station, that frequency is held.</p> <p>On the VF band, when there is judged to be a broadcast station by IF count and SD signal the SK switch is checked 250 to 375 ms later and if there is an SK signal, that frequency is held.</p> <p>When seek up (seek down) reaches the highest (lowest) frequency, it returns to the lowest (highest) frequency and, that is, sawtooth wave mode tuning is performed.</p> <p>The channel seek up (seek down) operation is shown below:</p> <table border="1" style="width: 100%; border-collapse: collapse; margin-top: 10px;"> <thead> <tr> <th style="width: 50%; text-align: center;">Seek Up</th> <th style="width: 50%; text-align: center;">Seek Down</th> </tr> </thead> <tbody> <tr> <td style="text-align: center; vertical-align: middle;"> </td> <td style="text-align: center; vertical-align: middle;"> </td> </tr> </tbody> </table> <p style="margin-top: 10px;">For the S (slow) and F (fast) IF count conditions, see the FMIF pin and AMIF pin above. For the 1 channel space frequency width, see the receiving frequencies above.</p>	Seek Up	Seek Down		
Seek Up	Seek Down				
	<p>When band switching is performed during the seek operation (no broadcast station), when switching returns to the same band and when the radio is turned off (including mode switching) and then turned back on, the frequency at which seek started is received.</p> <p>The keys that are valid during the seek operation are shown in the following table.</p> <p>Keys that are not shown are invalid. ( <span style="border: 1px solid black; padding: 2px;">POWER</span> key is valid.)</p> <p>When using the <span style="border: 1px solid black; padding: 2px;">SEEK UP</span> and <span style="border: 1px solid black; padding: 2px;">SEEK DWN</span> keys, set the AUTO 500 switch (diode matrix) to 0.</p>				



Symbol	Function																			
	<p>When the auto local function is used, the local mode is switched as shown below each time the <b>SEEK UP</b> or <b>SEEK DWN</b> key is pressed.</p> <p>LOCAL → DX → seek operation stop</p> <p>When the local mode is switched, seek is repeated from the frequency at which it started.</p>																			
	<table border="1" style="width: 100%; border-collapse: collapse;"> <thead> <tr> <th style="width: 20%; text-align: center;">Key</th> <th style="text-align: center;">Operation</th> </tr> </thead> <tbody> <tr> <td style="text-align: center;"> <div style="border: 1px solid black; padding: 2px; display: inline-block; margin-bottom: 5px;">SEEK UP</div>  <div style="border: 1px solid black; padding: 2px; display: inline-block;">SEEK DWN</div> </td> <td> <p>– <b>SEEK UP</b> key during seek up and <b>SEEK DWN</b> key during seek down Seek stops and returns to the frequency at which it started.</p> <p>However, when the auto local function is used, the local mode is switched.</p> <p>– <b>SEEK DWN</b> key during seek up and <b>SEEK UP</b> key during seek down Shifts to the operation of the pressed key (to seek down during seek up) from the frequency when the key was pressed.</p> <p>Key transfer operation is also enabled.</p> </td> </tr> <tr> <td style="text-align: center;"> <div style="border: 1px solid black; padding: 2px; display: inline-block; margin-bottom: 5px;">SCAN UP</div>  <div style="border: 1px solid black; padding: 2px; display: inline-block;">SCAN DWN</div> </td> <td> <p>Scan up (scan down) operation starts from the frequency when the key was pressed.</p> </td> </tr> <tr> <td style="text-align: center;"> <div style="border: 1px solid black; padding: 2px; display: inline-block; margin-bottom: 5px;">SEEK UP</div>  <div style="border: 1px solid black; padding: 2px; display: inline-block;">SEEK DWN</div> </td> <td style="text-align: center;"> <div style="border: 1px solid black; padding: 2px; display: inline-block; margin-bottom: 5px;">MAN UP</div>  <div style="border: 1px solid black; padding: 2px; display: inline-block;">MAN DWN</div> </td> <td> <p>Seek operation stops and returns to the frequency when seek started.</p> </td> </tr> <tr> <td style="text-align: center;"> <div style="border: 1px solid black; padding: 2px; display: inline-block;">BAND</div> </td> <td> <p>Seek operation stops and the band is switched sequentially as shown below.</p> <p style="text-align: center;">→ FM1 → FM2 → FM3 → MW1 → MW2 → LW →</p> <p>However, bands disabled by receiving area and DISFM3, ENMW2, and DISLW switches are skipped.</p> <p>When switching returns to the same, it becomes the frequency when seek started.</p> </td> </tr> <tr> <td style="text-align: center;"> <div style="border: 1px solid black; padding: 2px; display: inline-block; margin-bottom: 5px;">M1 (TP1)</div> to  <div style="border: 1px solid black; padding: 2px; display: inline-block;">M6</div> </td> <td> <p>The preset memory contents of the pressed key at the time the key was pressed are called without regard to the state of the M2S switch.</p> </td> </tr> <tr> <td style="text-align: center;"> <div style="border: 1px solid black; padding: 2px; display: inline-block;">VF</div> </td> <td> <p>Seek operation stops and the key operation is performed.</p> </td> </tr> <tr> <td style="text-align: center;"> <div style="border: 1px solid black; padding: 2px; display: inline-block;">PSCAN AMEMO</div> </td> <td> <p>Seek operation stops and preset scanning is performed.</p> </td> </tr> <tr> <td style="text-align: center;"> <div style="border: 1px solid black; padding: 2px; display: inline-block; margin-bottom: 5px;">LOUD</div>  <div style="border: 1px solid black; padding: 2px; display: inline-block; margin-bottom: 5px;">LOC (TP4)</div>  <div style="border: 1px solid black; padding: 2px; display: inline-block;">MONO (TP5)</div> </td> <td> <p>The operation of the pressed key is performed.</p> <p>The seek operation continues.</p> </td> </tr> </tbody> </table>	Key	Operation	<div style="border: 1px solid black; padding: 2px; display: inline-block; margin-bottom: 5px;">SEEK UP</div> <div style="border: 1px solid black; padding: 2px; display: inline-block;">SEEK DWN</div>	<p>– <b>SEEK UP</b> key during seek up and <b>SEEK DWN</b> key during seek down Seek stops and returns to the frequency at which it started.</p> <p>However, when the auto local function is used, the local mode is switched.</p> <p>– <b>SEEK DWN</b> key during seek up and <b>SEEK UP</b> key during seek down Shifts to the operation of the pressed key (to seek down during seek up) from the frequency when the key was pressed.</p> <p>Key transfer operation is also enabled.</p>	<div style="border: 1px solid black; padding: 2px; display: inline-block; margin-bottom: 5px;">SCAN UP</div> <div style="border: 1px solid black; padding: 2px; display: inline-block;">SCAN DWN</div>	<p>Scan up (scan down) operation starts from the frequency when the key was pressed.</p>	<div style="border: 1px solid black; padding: 2px; display: inline-block; margin-bottom: 5px;">SEEK UP</div> <div style="border: 1px solid black; padding: 2px; display: inline-block;">SEEK DWN</div>	<div style="border: 1px solid black; padding: 2px; display: inline-block; margin-bottom: 5px;">MAN UP</div> <div style="border: 1px solid black; padding: 2px; display: inline-block;">MAN DWN</div>	<p>Seek operation stops and returns to the frequency when seek started.</p>	<div style="border: 1px solid black; padding: 2px; display: inline-block;">BAND</div>	<p>Seek operation stops and the band is switched sequentially as shown below.</p> <p style="text-align: center;">→ FM1 → FM2 → FM3 → MW1 → MW2 → LW →</p> <p>However, bands disabled by receiving area and DISFM3, ENMW2, and DISLW switches are skipped.</p> <p>When switching returns to the same, it becomes the frequency when seek started.</p>	<div style="border: 1px solid black; padding: 2px; display: inline-block; margin-bottom: 5px;">M1 (TP1)</div> to <div style="border: 1px solid black; padding: 2px; display: inline-block;">M6</div>	<p>The preset memory contents of the pressed key at the time the key was pressed are called without regard to the state of the M2S switch.</p>	<div style="border: 1px solid black; padding: 2px; display: inline-block;">VF</div>	<p>Seek operation stops and the key operation is performed.</p>	<div style="border: 1px solid black; padding: 2px; display: inline-block;">PSCAN AMEMO</div>	<p>Seek operation stops and preset scanning is performed.</p>	<div style="border: 1px solid black; padding: 2px; display: inline-block; margin-bottom: 5px;">LOUD</div> <div style="border: 1px solid black; padding: 2px; display: inline-block; margin-bottom: 5px;">LOC (TP4)</div> <div style="border: 1px solid black; padding: 2px; display: inline-block;">MONO (TP5)</div>	<p>The operation of the pressed key is performed.</p> <p>The seek operation continues.</p>
Key	Operation																			
<div style="border: 1px solid black; padding: 2px; display: inline-block; margin-bottom: 5px;">SEEK UP</div> <div style="border: 1px solid black; padding: 2px; display: inline-block;">SEEK DWN</div>	<p>– <b>SEEK UP</b> key during seek up and <b>SEEK DWN</b> key during seek down Seek stops and returns to the frequency at which it started.</p> <p>However, when the auto local function is used, the local mode is switched.</p> <p>– <b>SEEK DWN</b> key during seek up and <b>SEEK UP</b> key during seek down Shifts to the operation of the pressed key (to seek down during seek up) from the frequency when the key was pressed.</p> <p>Key transfer operation is also enabled.</p>																			
<div style="border: 1px solid black; padding: 2px; display: inline-block; margin-bottom: 5px;">SCAN UP</div> <div style="border: 1px solid black; padding: 2px; display: inline-block;">SCAN DWN</div>	<p>Scan up (scan down) operation starts from the frequency when the key was pressed.</p>																			
<div style="border: 1px solid black; padding: 2px; display: inline-block; margin-bottom: 5px;">SEEK UP</div> <div style="border: 1px solid black; padding: 2px; display: inline-block;">SEEK DWN</div>	<div style="border: 1px solid black; padding: 2px; display: inline-block; margin-bottom: 5px;">MAN UP</div> <div style="border: 1px solid black; padding: 2px; display: inline-block;">MAN DWN</div>	<p>Seek operation stops and returns to the frequency when seek started.</p>																		
<div style="border: 1px solid black; padding: 2px; display: inline-block;">BAND</div>	<p>Seek operation stops and the band is switched sequentially as shown below.</p> <p style="text-align: center;">→ FM1 → FM2 → FM3 → MW1 → MW2 → LW →</p> <p>However, bands disabled by receiving area and DISFM3, ENMW2, and DISLW switches are skipped.</p> <p>When switching returns to the same, it becomes the frequency when seek started.</p>																			
<div style="border: 1px solid black; padding: 2px; display: inline-block; margin-bottom: 5px;">M1 (TP1)</div> to <div style="border: 1px solid black; padding: 2px; display: inline-block;">M6</div>	<p>The preset memory contents of the pressed key at the time the key was pressed are called without regard to the state of the M2S switch.</p>																			
<div style="border: 1px solid black; padding: 2px; display: inline-block;">VF</div>	<p>Seek operation stops and the key operation is performed.</p>																			
<div style="border: 1px solid black; padding: 2px; display: inline-block;">PSCAN AMEMO</div>	<p>Seek operation stops and preset scanning is performed.</p>																			
<div style="border: 1px solid black; padding: 2px; display: inline-block; margin-bottom: 5px;">LOUD</div> <div style="border: 1px solid black; padding: 2px; display: inline-block; margin-bottom: 5px;">LOC (TP4)</div> <div style="border: 1px solid black; padding: 2px; display: inline-block;">MONO (TP5)</div>	<p>The operation of the pressed key is performed.</p> <p>The seek operation continues.</p>																			

Symbol	Function										
<div style="border: 1px solid black; padding: 2px; margin-bottom: 5px; width: fit-content;">SCAN UP</div> <div style="border: 1px solid black; padding: 2px; margin-bottom: 5px; width: fit-content;">SCAN DWN</div>	<p>Auto tuning (scan operation) key.</p> <p>The frequencies are searched up ( <span style="border: 1px solid black; padding: 2px;">SCAN UP</span> key) or down ( <span style="border: 1px solid black; padding: 2px;">SCAN DWN</span> key) in 1 channel steps and whether or not there is a broadcast station ( IF count and SD signal ) is detected at each receiving frequency and when a broadcast station is judged to be present, that frequency is held for 5 seconds. On the VF band, whether or not there is an SK signal is detected as well as seek operation. If no operation is performed during this 5 seconds, the seek operation is repeated and the next broadcast station is received sequentially every 5 seconds (scan operation).</p> <p>During this 5 seconds hold, the frequency display flashes at 1 Hz (duty 50%).</p> <p>At the end of the 5 seconds hold, BEEP is output.</p> <p>Seek operations (channel up/down method, AUTOSTP switch and IF count, SD detection, SK signal detection) are the same as the <span style="border: 1px solid black; padding: 2px;">SEEK UP</span> and <span style="border: 1px solid black; padding: 2px;">SEEK DWN</span> keys. When the radio is turned off (including mode switching) and then turned on, the frequency held last (when there is not even 1 broadcast station, the frequency when the scan operation started) is received.</p> <p>The operation of each key during seek operation (other than at 5 seconds hold) is shown below.</p>										
<div style="border: 1px solid black; padding: 2px; margin-bottom: 5px; width: fit-content;">SCAN UP</div> <div style="border: 1px solid black; padding: 2px; margin-bottom: 5px; width: fit-content;">SCAN DWN</div>	<table border="1" style="width: 100%; border-collapse: collapse;"> <thead> <tr> <th style="width: 20%; text-align: center;">Key</th> <th style="text-align: center;">Operation</th> </tr> </thead> <tbody> <tr> <td style="vertical-align: top;"> <div style="border: 1px solid black; padding: 2px; margin-bottom: 5px; width: fit-content;">SCAN UP</div> <div style="border: 1px solid black; padding: 2px; margin-bottom: 5px; width: fit-content;">SCAN DWN</div> </td> <td> <ul style="list-style-type: none"> <li>- <span style="border: 1px solid black; padding: 2px;">SCAN UP</span> key during scan up and <span style="border: 1px solid black; padding: 2px;">SCAN DWN</span> key during scan down</li> </ul> <p>Scanning stops and returns to the frequency held last.</p> <p>However, when the auto local function is used, the local mode is switched.</p> <ul style="list-style-type: none"> <li>- <span style="border: 1px solid black; padding: 2px;">SCAN DWN</span> key during scan up and <span style="border: 1px solid black; padding: 2px;">SCAN UP</span> key during scan down</li> </ul> <p>Operation shifts to operation of the pressed key from the frequency when the key was pressed.</p> </td> </tr> <tr> <td style="vertical-align: top;"> <div style="border: 1px solid black; padding: 2px; margin-bottom: 5px; width: fit-content;">SEEK UP</div> <div style="border: 1px solid black; padding: 2px; margin-bottom: 5px; width: fit-content;">SEEK DWN</div> </td> <td> <p>Scanning stops and seek operation starts from the frequency when the key was pressed.</p> </td> </tr> <tr> <td style="vertical-align: top;"> <div style="border: 1px solid black; padding: 2px; margin-bottom: 5px; width: fit-content;">MAN UP</div> <div style="border: 1px solid black; padding: 2px; margin-bottom: 5px; width: fit-content;">MAN DWN</div> </td> <td> <p>Scanning stops and returns to the frequency held last (when a frequency was not held, returns to the frequency when scanning started).</p> <p>Scanning stops whenever any of these keys is pressed even though the AUTO500 switch is 1 (when the <span style="border: 1px solid black; padding: 2px;">MAN UP</span> or <span style="border: 1px solid black; padding: 2px;">MAN DWN</span> key is pressed for more than 0.5 seconds, seek is performed).</p> </td> </tr> <tr> <td style="vertical-align: top;"> <div style="border: 1px solid black; padding: 2px; margin-bottom: 5px; width: fit-content;">BAND</div> </td> <td> <p>Scanning stops and the band is switched sequentially as shown below.</p> <div style="text-align: center; border: 1px solid black; padding: 5px; margin: 10px 0;"> <span style="border: 1px solid black; padding: 2px;">FM1</span> → <span style="border: 1px solid black; padding: 2px;">FM2</span> → <span style="border: 1px solid black; padding: 2px;">FM3</span> → <span style="border: 1px solid black; padding: 2px;">MW1</span> → <span style="border: 1px solid black; padding: 2px;">MW2</span> → <span style="border: 1px solid black; padding: 2px;">LW</span> </div> <p>However, bands disabled by receiving area and DISFM3, ENMW2 and DISLW switches are skipped.</p> <p>When switching returns to the same band, the frequency held last is received.</p> <p>When a frequency was not held, the frequency when scanning started is received.</p> </td> </tr> </tbody> </table>	Key	Operation	<div style="border: 1px solid black; padding: 2px; margin-bottom: 5px; width: fit-content;">SCAN UP</div> <div style="border: 1px solid black; padding: 2px; margin-bottom: 5px; width: fit-content;">SCAN DWN</div>	<ul style="list-style-type: none"> <li>- <span style="border: 1px solid black; padding: 2px;">SCAN UP</span> key during scan up and <span style="border: 1px solid black; padding: 2px;">SCAN DWN</span> key during scan down</li> </ul> <p>Scanning stops and returns to the frequency held last.</p> <p>However, when the auto local function is used, the local mode is switched.</p> <ul style="list-style-type: none"> <li>- <span style="border: 1px solid black; padding: 2px;">SCAN DWN</span> key during scan up and <span style="border: 1px solid black; padding: 2px;">SCAN UP</span> key during scan down</li> </ul> <p>Operation shifts to operation of the pressed key from the frequency when the key was pressed.</p>	<div style="border: 1px solid black; padding: 2px; margin-bottom: 5px; width: fit-content;">SEEK UP</div> <div style="border: 1px solid black; padding: 2px; margin-bottom: 5px; width: fit-content;">SEEK DWN</div>	<p>Scanning stops and seek operation starts from the frequency when the key was pressed.</p>	<div style="border: 1px solid black; padding: 2px; margin-bottom: 5px; width: fit-content;">MAN UP</div> <div style="border: 1px solid black; padding: 2px; margin-bottom: 5px; width: fit-content;">MAN DWN</div>	<p>Scanning stops and returns to the frequency held last (when a frequency was not held, returns to the frequency when scanning started).</p> <p>Scanning stops whenever any of these keys is pressed even though the AUTO500 switch is 1 (when the <span style="border: 1px solid black; padding: 2px;">MAN UP</span> or <span style="border: 1px solid black; padding: 2px;">MAN DWN</span> key is pressed for more than 0.5 seconds, seek is performed).</p>	<div style="border: 1px solid black; padding: 2px; margin-bottom: 5px; width: fit-content;">BAND</div>	<p>Scanning stops and the band is switched sequentially as shown below.</p> <div style="text-align: center; border: 1px solid black; padding: 5px; margin: 10px 0;"> <span style="border: 1px solid black; padding: 2px;">FM1</span> → <span style="border: 1px solid black; padding: 2px;">FM2</span> → <span style="border: 1px solid black; padding: 2px;">FM3</span> → <span style="border: 1px solid black; padding: 2px;">MW1</span> → <span style="border: 1px solid black; padding: 2px;">MW2</span> → <span style="border: 1px solid black; padding: 2px;">LW</span> </div> <p>However, bands disabled by receiving area and DISFM3, ENMW2 and DISLW switches are skipped.</p> <p>When switching returns to the same band, the frequency held last is received.</p> <p>When a frequency was not held, the frequency when scanning started is received.</p>
Key	Operation										
<div style="border: 1px solid black; padding: 2px; margin-bottom: 5px; width: fit-content;">SCAN UP</div> <div style="border: 1px solid black; padding: 2px; margin-bottom: 5px; width: fit-content;">SCAN DWN</div>	<ul style="list-style-type: none"> <li>- <span style="border: 1px solid black; padding: 2px;">SCAN UP</span> key during scan up and <span style="border: 1px solid black; padding: 2px;">SCAN DWN</span> key during scan down</li> </ul> <p>Scanning stops and returns to the frequency held last.</p> <p>However, when the auto local function is used, the local mode is switched.</p> <ul style="list-style-type: none"> <li>- <span style="border: 1px solid black; padding: 2px;">SCAN DWN</span> key during scan up and <span style="border: 1px solid black; padding: 2px;">SCAN UP</span> key during scan down</li> </ul> <p>Operation shifts to operation of the pressed key from the frequency when the key was pressed.</p>										
<div style="border: 1px solid black; padding: 2px; margin-bottom: 5px; width: fit-content;">SEEK UP</div> <div style="border: 1px solid black; padding: 2px; margin-bottom: 5px; width: fit-content;">SEEK DWN</div>	<p>Scanning stops and seek operation starts from the frequency when the key was pressed.</p>										
<div style="border: 1px solid black; padding: 2px; margin-bottom: 5px; width: fit-content;">MAN UP</div> <div style="border: 1px solid black; padding: 2px; margin-bottom: 5px; width: fit-content;">MAN DWN</div>	<p>Scanning stops and returns to the frequency held last (when a frequency was not held, returns to the frequency when scanning started).</p> <p>Scanning stops whenever any of these keys is pressed even though the AUTO500 switch is 1 (when the <span style="border: 1px solid black; padding: 2px;">MAN UP</span> or <span style="border: 1px solid black; padding: 2px;">MAN DWN</span> key is pressed for more than 0.5 seconds, seek is performed).</p>										
<div style="border: 1px solid black; padding: 2px; margin-bottom: 5px; width: fit-content;">BAND</div>	<p>Scanning stops and the band is switched sequentially as shown below.</p> <div style="text-align: center; border: 1px solid black; padding: 5px; margin: 10px 0;"> <span style="border: 1px solid black; padding: 2px;">FM1</span> → <span style="border: 1px solid black; padding: 2px;">FM2</span> → <span style="border: 1px solid black; padding: 2px;">FM3</span> → <span style="border: 1px solid black; padding: 2px;">MW1</span> → <span style="border: 1px solid black; padding: 2px;">MW2</span> → <span style="border: 1px solid black; padding: 2px;">LW</span> </div> <p>However, bands disabled by receiving area and DISFM3, ENMW2 and DISLW switches are skipped.</p> <p>When switching returns to the same band, the frequency held last is received.</p> <p>When a frequency was not held, the frequency when scanning started is received.</p>										

Symbol	Function										
	<table border="1" style="width: 100%; border-collapse: collapse;"> <thead> <tr> <th style="width: 20%;">Key</th> <th>Operation</th> </tr> </thead> <tbody> <tr> <td> <div style="border: 1px solid black; padding: 2px; display: inline-block; margin-bottom: 5px;">M1 (TP1)</div> to  <div style="border: 1px solid black; padding: 2px; display: inline-block; margin-bottom: 5px;">M6</div> </td> <td>When a key is pressed, scanning stops and the preset memory contents of the pressed key are called without regard to the state of the M2S switch.</td> </tr> <tr> <td> <div style="border: 1px solid black; padding: 2px; display: inline-block; margin-bottom: 5px;">VF</div> </td> <td>Scanning stops and operation of the key is performed.</td> </tr> <tr> <td> <div style="border: 1px solid black; padding: 2px; display: inline-block; margin-bottom: 5px;">PSCAN AMEMO</div> </td> <td>Scanning stops and preset scan is performed from M1.</td> </tr> <tr> <td> <div style="border: 1px solid black; padding: 2px; display: inline-block; margin-bottom: 5px;">LOUD</div>  <div style="border: 1px solid black; padding: 2px; display: inline-block; margin-bottom: 5px;">LOC (TP4)</div>  <div style="border: 1px solid black; padding: 2px; display: inline-block; margin-bottom: 5px;">MONO (TP5)</div> </td> <td>The operation of the pressed key is performed. Seek (scan operation) continues.</td> </tr> </tbody> </table>	Key	Operation	<div style="border: 1px solid black; padding: 2px; display: inline-block; margin-bottom: 5px;">M1 (TP1)</div> to <div style="border: 1px solid black; padding: 2px; display: inline-block; margin-bottom: 5px;">M6</div>	When a key is pressed, scanning stops and the preset memory contents of the pressed key are called without regard to the state of the M2S switch.	<div style="border: 1px solid black; padding: 2px; display: inline-block; margin-bottom: 5px;">VF</div>	Scanning stops and operation of the key is performed.	<div style="border: 1px solid black; padding: 2px; display: inline-block; margin-bottom: 5px;">PSCAN AMEMO</div>	Scanning stops and preset scan is performed from M1.	<div style="border: 1px solid black; padding: 2px; display: inline-block; margin-bottom: 5px;">LOUD</div> <div style="border: 1px solid black; padding: 2px; display: inline-block; margin-bottom: 5px;">LOC (TP4)</div> <div style="border: 1px solid black; padding: 2px; display: inline-block; margin-bottom: 5px;">MONO (TP5)</div>	The operation of the pressed key is performed. Seek (scan operation) continues.
Key	Operation										
<div style="border: 1px solid black; padding: 2px; display: inline-block; margin-bottom: 5px;">M1 (TP1)</div> to <div style="border: 1px solid black; padding: 2px; display: inline-block; margin-bottom: 5px;">M6</div>	When a key is pressed, scanning stops and the preset memory contents of the pressed key are called without regard to the state of the M2S switch.										
<div style="border: 1px solid black; padding: 2px; display: inline-block; margin-bottom: 5px;">VF</div>	Scanning stops and operation of the key is performed.										
<div style="border: 1px solid black; padding: 2px; display: inline-block; margin-bottom: 5px;">PSCAN AMEMO</div>	Scanning stops and preset scan is performed from M1.										
<div style="border: 1px solid black; padding: 2px; display: inline-block; margin-bottom: 5px;">LOUD</div> <div style="border: 1px solid black; padding: 2px; display: inline-block; margin-bottom: 5px;">LOC (TP4)</div> <div style="border: 1px solid black; padding: 2px; display: inline-block; margin-bottom: 5px;">MONO (TP5)</div>	The operation of the pressed key is performed. Seek (scan operation) continues.										
<div style="border: 1px solid black; padding: 2px; display: inline-block; margin-bottom: 5px;">SCAN UP</div> <div style="border: 1px solid black; padding: 2px; display: inline-block; margin-bottom: 5px;">SCAN DWN</div>	<p>Momentary keys other than those described above are invalid. (However, the <span style="border: 1px solid black; padding: 2px; display: inline-block;">POWER</span> key is valid.)</p> <p>Operation of each key during 5 second hold is shown below.</p> <table border="1" style="width: 100%; border-collapse: collapse;"> <thead> <tr> <th style="width: 20%;">Key</th> <th>Operation</th> </tr> </thead> <tbody> <tr> <td> <div style="border: 1px solid black; padding: 2px; display: inline-block; margin-bottom: 5px;">SCAN UP</div>  <div style="border: 1px solid black; padding: 2px; display: inline-block; margin-bottom: 5px;">SCAN DWN</div> </td> <td> <ul style="list-style-type: none"> <li>- <span style="border: 1px solid black; padding: 2px; display: inline-block;">SCAN UP</span> key during scan up and <span style="border: 1px solid black; padding: 2px; display: inline-block;">SCAN DWN</span> key during scan down Scanning stops and the frequency being held is locked in.</li> <li>- <span style="border: 1px solid black; padding: 2px; display: inline-block;">SCAN DWN</span> key during scan up and <span style="border: 1px solid black; padding: 2px; display: inline-block;">SCAN UP</span> key during scan down And then the operation of the pressed key is performed.</li> </ul> </td> </tr> <tr> <td> <div style="border: 1px solid black; padding: 2px; display: inline-block; margin-bottom: 5px;">SEEK UP</div>  <div style="border: 1px solid black; padding: 2px; display: inline-block; margin-bottom: 5px;">SEEK DWN</div> </td> <td>Scanning stops and a seek starts from the frequency being held.</td> </tr> <tr> <td> <div style="border: 1px solid black; padding: 2px; display: inline-block; margin-bottom: 5px;">MAN UP</div>  <div style="border: 1px solid black; padding: 2px; display: inline-block; margin-bottom: 5px;">MAN DWN</div> </td> <td>Scanning stops and operation of the <span style="border: 1px solid black; padding: 2px; display: inline-block;">MAN UP</span> or <span style="border: 1px solid black; padding: 2px; display: inline-block;">MAN DWN</span> key is performed from the frequency being held.</td> </tr> <tr> <td> <div style="border: 1px solid black; padding: 2px; display: inline-block; margin-bottom: 5px;">BAND</div> </td> <td> <p>Scanning stops and the band is switched sequentially as shown below.</p> <div style="text-align: center; margin: 10px 0;"> <span style="border: 1px solid black; padding: 2px;">FM1</span> → <span style="border: 1px solid black; padding: 2px;">FM2</span> → <span style="border: 1px solid black; padding: 2px;">FM3</span> → <span style="border: 1px solid black; padding: 2px;">MW1</span> → <span style="border: 1px solid black; padding: 2px;">MW2</span> → <span style="border: 1px solid black; padding: 2px;">LW</span> </div> <p>However, bands disabled by receiving area and DISFM3, ENMW2 and DISLW switches are skipped. When switching returns to the same band, it returns to the held frequency.</p> </td> </tr> </tbody> </table>	Key	Operation	<div style="border: 1px solid black; padding: 2px; display: inline-block; margin-bottom: 5px;">SCAN UP</div> <div style="border: 1px solid black; padding: 2px; display: inline-block; margin-bottom: 5px;">SCAN DWN</div>	<ul style="list-style-type: none"> <li>- <span style="border: 1px solid black; padding: 2px; display: inline-block;">SCAN UP</span> key during scan up and <span style="border: 1px solid black; padding: 2px; display: inline-block;">SCAN DWN</span> key during scan down Scanning stops and the frequency being held is locked in.</li> <li>- <span style="border: 1px solid black; padding: 2px; display: inline-block;">SCAN DWN</span> key during scan up and <span style="border: 1px solid black; padding: 2px; display: inline-block;">SCAN UP</span> key during scan down And then the operation of the pressed key is performed.</li> </ul>	<div style="border: 1px solid black; padding: 2px; display: inline-block; margin-bottom: 5px;">SEEK UP</div> <div style="border: 1px solid black; padding: 2px; display: inline-block; margin-bottom: 5px;">SEEK DWN</div>	Scanning stops and a seek starts from the frequency being held.	<div style="border: 1px solid black; padding: 2px; display: inline-block; margin-bottom: 5px;">MAN UP</div> <div style="border: 1px solid black; padding: 2px; display: inline-block; margin-bottom: 5px;">MAN DWN</div>	Scanning stops and operation of the <span style="border: 1px solid black; padding: 2px; display: inline-block;">MAN UP</span> or <span style="border: 1px solid black; padding: 2px; display: inline-block;">MAN DWN</span> key is performed from the frequency being held.	<div style="border: 1px solid black; padding: 2px; display: inline-block; margin-bottom: 5px;">BAND</div>	<p>Scanning stops and the band is switched sequentially as shown below.</p> <div style="text-align: center; margin: 10px 0;"> <span style="border: 1px solid black; padding: 2px;">FM1</span> → <span style="border: 1px solid black; padding: 2px;">FM2</span> → <span style="border: 1px solid black; padding: 2px;">FM3</span> → <span style="border: 1px solid black; padding: 2px;">MW1</span> → <span style="border: 1px solid black; padding: 2px;">MW2</span> → <span style="border: 1px solid black; padding: 2px;">LW</span> </div> <p>However, bands disabled by receiving area and DISFM3, ENMW2 and DISLW switches are skipped. When switching returns to the same band, it returns to the held frequency.</p>
Key	Operation										
<div style="border: 1px solid black; padding: 2px; display: inline-block; margin-bottom: 5px;">SCAN UP</div> <div style="border: 1px solid black; padding: 2px; display: inline-block; margin-bottom: 5px;">SCAN DWN</div>	<ul style="list-style-type: none"> <li>- <span style="border: 1px solid black; padding: 2px; display: inline-block;">SCAN UP</span> key during scan up and <span style="border: 1px solid black; padding: 2px; display: inline-block;">SCAN DWN</span> key during scan down Scanning stops and the frequency being held is locked in.</li> <li>- <span style="border: 1px solid black; padding: 2px; display: inline-block;">SCAN DWN</span> key during scan up and <span style="border: 1px solid black; padding: 2px; display: inline-block;">SCAN UP</span> key during scan down And then the operation of the pressed key is performed.</li> </ul>										
<div style="border: 1px solid black; padding: 2px; display: inline-block; margin-bottom: 5px;">SEEK UP</div> <div style="border: 1px solid black; padding: 2px; display: inline-block; margin-bottom: 5px;">SEEK DWN</div>	Scanning stops and a seek starts from the frequency being held.										
<div style="border: 1px solid black; padding: 2px; display: inline-block; margin-bottom: 5px;">MAN UP</div> <div style="border: 1px solid black; padding: 2px; display: inline-block; margin-bottom: 5px;">MAN DWN</div>	Scanning stops and operation of the <span style="border: 1px solid black; padding: 2px; display: inline-block;">MAN UP</span> or <span style="border: 1px solid black; padding: 2px; display: inline-block;">MAN DWN</span> key is performed from the frequency being held.										
<div style="border: 1px solid black; padding: 2px; display: inline-block; margin-bottom: 5px;">BAND</div>	<p>Scanning stops and the band is switched sequentially as shown below.</p> <div style="text-align: center; margin: 10px 0;"> <span style="border: 1px solid black; padding: 2px;">FM1</span> → <span style="border: 1px solid black; padding: 2px;">FM2</span> → <span style="border: 1px solid black; padding: 2px;">FM3</span> → <span style="border: 1px solid black; padding: 2px;">MW1</span> → <span style="border: 1px solid black; padding: 2px;">MW2</span> → <span style="border: 1px solid black; padding: 2px;">LW</span> </div> <p>However, bands disabled by receiving area and DISFM3, ENMW2 and DISLW switches are skipped. When switching returns to the same band, it returns to the held frequency.</p>										

# DMC 4001

Symbol	Function												
<div style="border: 1px solid black; width: 60px; height: 20px; margin-bottom: 5px; text-align: center;">SCAN UP</div> <div style="border: 1px solid black; width: 60px; height: 20px; margin-bottom: 5px; text-align: center;">SCAN DWN</div>	<table border="1" style="width: 100%; border-collapse: collapse;"> <thead> <tr> <th style="width: 15%; text-align: center;">Key</th> <th style="text-align: center;">Operation</th> </tr> </thead> <tbody> <tr> <td style="text-align: center; vertical-align: middle;">ME</td> <td style="padding: 10px;"> <p>- When the M2S switch is 1, this key is invalid. - When M2S switch = 0</p> <p>Each time the key is pressed, the memory write state is inverted as shown below.</p> <p>(i)</p> <p>(ii)</p> <p>When a <span style="border: 1px solid black; padding: 2px;">M1 (TP1)</span> to <span style="border: 1px solid black; padding: 2px;">M6</span> key is pressed in the memory writable state, data is written to the present memory corresponding to the pressed key.</p> </td> </tr> <tr> <td style="text-align: center; vertical-align: middle;">VF</td> <td>Scanning is canceled and the key operation is performed.</td> </tr> <tr> <td style="text-align: center; vertical-align: middle;">PSCAN AMEMO</td> <td>Scanning is canceled and the key operation is performed.</td> </tr> <tr> <td style="text-align: center; vertical-align: middle;">LOUD</td> <td rowspan="3">The operation of the pressed key is performed. Scanning continues.</td> </tr> <tr> <td style="text-align: center; vertical-align: middle;">LOC (TP4)</td> </tr> <tr> <td style="text-align: center; vertical-align: middle;">MONO (TP5)</td> </tr> </tbody> </table>	Key	Operation	ME	<p>- When the M2S switch is 1, this key is invalid. - When M2S switch = 0</p> <p>Each time the key is pressed, the memory write state is inverted as shown below.</p> <p>(i)</p> <p>(ii)</p> <p>When a <span style="border: 1px solid black; padding: 2px;">M1 (TP1)</span> to <span style="border: 1px solid black; padding: 2px;">M6</span> key is pressed in the memory writable state, data is written to the present memory corresponding to the pressed key.</p>	VF	Scanning is canceled and the key operation is performed.	PSCAN AMEMO	Scanning is canceled and the key operation is performed.	LOUD	The operation of the pressed key is performed. Scanning continues.	LOC (TP4)	MONO (TP5)
Key	Operation												
ME	<p>- When the M2S switch is 1, this key is invalid. - When M2S switch = 0</p> <p>Each time the key is pressed, the memory write state is inverted as shown below.</p> <p>(i)</p> <p>(ii)</p> <p>When a <span style="border: 1px solid black; padding: 2px;">M1 (TP1)</span> to <span style="border: 1px solid black; padding: 2px;">M6</span> key is pressed in the memory writable state, data is written to the present memory corresponding to the pressed key.</p>												
VF	Scanning is canceled and the key operation is performed.												
PSCAN AMEMO	Scanning is canceled and the key operation is performed.												
LOUD	The operation of the pressed key is performed. Scanning continues.												
LOC (TP4)													
MONO (TP5)													

Symbol	Function
<div style="border: 1px solid black; padding: 2px; margin-bottom: 5px; width: fit-content;">SCAN UP</div> <div style="border: 1px solid black; padding: 2px; margin-bottom: 5px; width: fit-content;">SCAN DWN</div> <div style="border: 1px solid black; padding: 2px; margin-bottom: 5px; width: fit-content; margin-left: 20px;">M1 (TP1)</div> <div style="border: 1px solid black; padding: 2px; margin-bottom: 5px; width: fit-content; margin-left: 20px;">M2 (TP2)</div> <div style="border: 1px solid black; padding: 2px; margin-bottom: 5px; width: fit-content; margin-left: 20px;">M3 (TP3)</div> <div style="border: 1px solid black; padding: 2px; margin-bottom: 5px; width: fit-content; margin-left: 20px;">M4</div> <div style="border: 1px solid black; padding: 2px; margin-bottom: 5px; width: fit-content; margin-left: 20px;">M5</div> <div style="border: 1px solid black; padding: 2px; margin-bottom: 5px; width: fit-content; margin-left: 20px;">M6</div>	<div style="text-align: center; border-bottom: 1px solid black; margin-bottom: 5px;"> <span style="border: 1px solid black; padding: 2px;">Key</span> <span style="margin-left: 100px;">Operation</span> </div> <ul style="list-style-type: none"> <li>• When M2S switch = 0           <ul style="list-style-type: none"> <li>- Memory unwriteable state. The scanning operation is canceled and the preset memory contents corresponding to the pressed key is called.</li> <li>- Memory writable state (See the <span style="border: 1px solid black; padding: 2px;">ME</span> key below.) The held frequency is written to the preset memory corresponding to the pressed key and the memory writable state is canceled. Then, the hold state is held for 2 seconds. If an operation is not performed during this time, the next station is searched.</li> </ul> </li> </ul> <div style="margin-top: 10px;"> <p>(Example)</p> </div> <ul style="list-style-type: none"> <li>• When M2S switch = 1           <ul style="list-style-type: none"> <li>- When key released within 2 seconds The preset memory contents corresponding to the pressed key are called and the scan operation is reset the moment the key is released.</li> </ul> </li> </ul> <div style="margin-top: 10px;"> <p>(Example)</p> </div> <ul style="list-style-type: none"> <li>- When key pressed for more than 2 seconds The held frequency is written to the preset memory corresponding to the pressed key 2 seconds after the key has been passed for 2 seconds. 2 seconds after the end of writing, hold ends and the next station is searched (seek operation).</li> </ul> <div style="margin-top: 10px;"> <p>(Example)</p> </div>

Symbol	Function				
<div style="border: 1px solid black; padding: 2px; width: fit-content; margin: 0 auto;">BAND</div>	<p>Receiving band selection switch It is valid only in the radio mode. Each time this switch is pressed, the band is switched sequentially as shown below.</p> <div style="text-align: center; border: 1px solid black; padding: 5px; margin: 10px auto; width: fit-content;">             FM1 → FM2 → FM3 → MW1 → MW2 → LW           </div> <p>However, bands disabled by receiving area and DISFM3, ENMW2, and DISLW switches are skipped. When the band is switched (FM1 · FM2 · FM3 · MW1 · MW2) in the same band (FM, MW), the band display and last channel change. When the <span style="border: 1px solid black; padding: 2px;">BAND</span> key is pressed during VF band reception, the VF band is reset and the device returns to the band received last.</p>				
<div style="border: 1px solid black; padding: 2px; width: fit-content; margin: 0 auto;">ME</div>	<p>In the radio mode, during frequency display, this key is used as the preset memory writable state setting key and during clock display (CE = High), this key is used with the <span style="border: 1px solid black; padding: 2px;">MAN UP</span> and <span style="border: 1px solid black; padding: 2px;">MAN DWN</span> keys as the clock adjustment key. When the M2S = 0, this key operates as the preset memory writable state and clock adjustment key. When M2S = 1, this key operates as the preset memory writable state and clock adjustment key. When M2S = 0, use the <span style="border: 1px solid black; padding: 2px;">DISP</span> key to switch the display. This key operation is described below.</p> <ul style="list-style-type: none"> <li>● Radio mode frequency display           <p>This key is used as the preset memory writable state setting key. It is valid only when the initialized diode M2S switch is 0. When this key is pressed, the device enters the preset memory writable state for 5 seconds and the current receiving frequency is written to the preset memory corresponding to the pressed key by pressing the <span style="border: 1px solid black; padding: 2px;">M1 (TP1)</span> to <span style="border: 1px solid black; padding: 2px;">M6</span> key. If the <span style="border: 1px solid black; padding: 2px;">ME</span> key is pressed continuously at this time, the write operation is not performed.</p> <p>During the preset memory writable state, the "ch" display flashes at 1 Hz (duty 50%). If preset memory is being received, the preset memory number flashes also.</p> <p>This key is invalid during the seek operation (including seek operation at scanning). However, it is valid at 5 seconds hold during the preset memory scan and scan operations. Each key operation in the preset memory writable state is shown below.</p> </li> </ul> <table border="1" style="width: 100%; border-collapse: collapse; margin-top: 10px;"> <thead> <tr> <th style="width: 20%; text-align: center;">Key</th> <th style="text-align: center;">Operation</th> </tr> </thead> <tbody> <tr> <td style="text-align: center;"> <div style="border: 1px solid black; padding: 2px; width: fit-content; margin: 0 auto;">M1 (TP1)</div>           to  <div style="border: 1px solid black; padding: 2px; width: fit-content; margin: 0 auto;">M6</div> </td> <td>           The frequency being received when a key is pressed is written to the preset memory corresponding to the pressed key. Muting is not output.         </td> </tr> </tbody> </table>	Key	Operation	<div style="border: 1px solid black; padding: 2px; width: fit-content; margin: 0 auto;">M1 (TP1)</div> to <div style="border: 1px solid black; padding: 2px; width: fit-content; margin: 0 auto;">M6</div>	The frequency being received when a key is pressed is written to the preset memory corresponding to the pressed key. Muting is not output.
Key	Operation				
<div style="border: 1px solid black; padding: 2px; width: fit-content; margin: 0 auto;">M1 (TP1)</div> to <div style="border: 1px solid black; padding: 2px; width: fit-content; margin: 0 auto;">M6</div>	The frequency being received when a key is pressed is written to the preset memory corresponding to the pressed key. Muting is not output.				

# DMC 4001

Symbol	Function											
<div style="border: 1px solid black; padding: 2px; width: fit-content; margin-bottom: 5px;">ME</div>	<table border="1" style="width: 100%; border-collapse: collapse;"> <thead> <tr> <th style="text-align: center;">Key</th> </tr> </thead> <tbody> <tr><td style="text-align: center;">VF</td></tr> <tr><td style="text-align: center;">PSCAN AMEMO</td></tr> <tr><td style="text-align: center;">SEEK UP</td></tr> <tr><td style="text-align: center;">SEEK DWN</td></tr> <tr><td style="text-align: center;">SCAN UP</td></tr> <tr><td style="text-align: center;">SCAN DWN</td></tr> <tr><td style="text-align: center;">MAN UP</td></tr> <tr><td style="text-align: center;">MAN DWN</td></tr> <tr><td style="text-align: center;">DISP</td></tr> </tbody> </table>	Key	VF	PSCAN AMEMO	SEEK UP	SEEK DWN	SCAN UP	SCAN DWN	MAN UP	MAN DWN	DISP	<p style="text-align: center;">Operation</p> <p>Preset memory write mode is reset and each key operation is performed.</p>
	Key											
	VF											
	PSCAN AMEMO											
SEEK UP												
SEEK DWN												
SCAN UP												
SCAN DWN												
MAN UP												
MAN DWN												
DISP												
<div style="border: 1px solid black; padding: 2px; width: fit-content; margin: 0 auto;">BAND</div>	<p>The preset memory writable state is reset and the band is switched sequentially as shown below.</p> <p style="text-align: center;"> <span style="border: 1px solid black; padding: 2px;">FM1</span> → <span style="border: 1px solid black; padding: 2px;">FM2</span> → <span style="border: 1px solid black; padding: 2px;">FM3</span> → <span style="border: 1px solid black; padding: 2px;">MW1</span> → <span style="border: 1px solid black; padding: 2px;">MW2</span> → <span style="border: 1px solid black; padding: 2px;">LW</span> </p> <p>However, bands disabled by receiving area and DISFM3, ENMW2 and DISLW switches are skipped.</p>											
<div style="border: 1px solid black; padding: 2px; width: fit-content; margin: 0 auto;">ME</div>	<p>The preset memory writable state is reset.</p>											
<table border="1" style="width: 100%; border-collapse: collapse;"> <tbody> <tr><td style="text-align: center;">LOUD</td></tr> <tr><td style="text-align: center;">LOC (TP4)</td></tr> <tr><td style="text-align: center;">MONO (TP5)</td></tr> </tbody> </table>	LOUD	LOC (TP4)	MONO (TP5)	<p>The preset memory writable state is held and each key operation is performed.</p>								
LOUD												
LOC (TP4)												
MONO (TP5)												

Keys other than those described above (except the POWER key) are invalid.

When the radio is turned off and then turned back on (including tape and CD mode switching) in the preset memory writable state, the writable state is released.

- Clock display
 

This key is used as the time adjustment key.

The minute and hour digits are adjusted as shown below by pressing the MAN UP and MAN DWN keys while pressing the ME key.

  - Hour adjustment
 

The hour is advanced one hour each time the MAN DWN key is pressed. When the key is held down for more than 0.5 seconds, the hour changes continuously at a speed of 4 hours/sec (1 hour in 250 ms) until the key is released.

The minute digit and seconds count are not affected.
  - Minute digit adjustment
 

The minute digit is advanced one minute each time the MAN UP key is pressed.

When the key held down for more than 0.5 seconds, the minute digit changes at a speed of 8 minutes/sec (1 minute in 125 ms) until the key is released. Carry to the hour digit is not performed.

Each time the minute digit is adjusted, the seconds count is reset.

# DMC 4001

Symbol	Function				
	<p>In the radio mode, these keys are used as the receiving frequency up/down keys. During clock display, these keys are used with the <span style="border: 1px solid black; padding: 2px;">ME</span> key as the clock adjustment keys. Their operation is shown below.</p> <ul style="list-style-type: none"> <li>• Radio mode</li> </ul> <p>These keys operate as shown below, depending on the setting of the initialized diode matrix AUTO 500 switch.</p> <p style="margin-left: 20px;">- Operation by AUTO 500 switch</p>				
	<table border="1" style="width: 100%; border-collapse: collapse;"> <thead> <tr> <th style="width: 20%;">AUTO500</th> <th style="text-align: center;">Description</th> </tr> </thead> <tbody> <tr> <td style="text-align: center; vertical-align: top;">0</td> <td> <p>Each time a key is pressed, the frequency is incremented ( <span style="border: 1px solid black; padding: 2px;">MAN UP</span> key) or decremented ( <span style="border: 1px solid black; padding: 2px;">MAN DWN</span> key) one step (1 channel space). When the key is held down for approx. 0.5 seconds, the frequency changes continuously at a speed of approx. 50 ms per step until the key is released.</p> <p>Example 1) When key released within 0.5 seconds</p> <p style="margin-left: 40px;">Frequency   87.5   87.6   87.7   87.8</p> <p>Example 2) When key held down for more than 0.5 seconds</p> <p style="margin-left: 40px;">Frequency   87.5   87.6   87.7   87.8   87.9   88.0   88.1</p> </td> </tr> </tbody> </table>	AUTO500	Description	0	<p>Each time a key is pressed, the frequency is incremented ( <span style="border: 1px solid black; padding: 2px;">MAN UP</span> key) or decremented ( <span style="border: 1px solid black; padding: 2px;">MAN DWN</span> key) one step (1 channel space). When the key is held down for approx. 0.5 seconds, the frequency changes continuously at a speed of approx. 50 ms per step until the key is released.</p> <p>Example 1) When key released within 0.5 seconds</p> <p style="margin-left: 40px;">Frequency   87.5   87.6   87.7   87.8</p> <p>Example 2) When key held down for more than 0.5 seconds</p> <p style="margin-left: 40px;">Frequency   87.5   87.6   87.7   87.8   87.9   88.0   88.1</p>
AUTO500	Description				
0	<p>Each time a key is pressed, the frequency is incremented ( <span style="border: 1px solid black; padding: 2px;">MAN UP</span> key) or decremented ( <span style="border: 1px solid black; padding: 2px;">MAN DWN</span> key) one step (1 channel space). When the key is held down for approx. 0.5 seconds, the frequency changes continuously at a speed of approx. 50 ms per step until the key is released.</p> <p>Example 1) When key released within 0.5 seconds</p> <p style="margin-left: 40px;">Frequency   87.5   87.6   87.7   87.8</p> <p>Example 2) When key held down for more than 0.5 seconds</p> <p style="margin-left: 40px;">Frequency   87.5   87.6   87.7   87.8   87.9   88.0   88.1</p>				

MAN UP

MAN DWN



Symbol	Function				
<div style="border: 1px solid black; width: 50px; height: 20px; margin-bottom: 5px; text-align: center; line-height: 20px;">MAN UP</div> <div style="border: 1px solid black; width: 50px; height: 20px; margin-bottom: 5px; text-align: center; line-height: 20px;">MAN DWN</div>	<table border="1" style="width: 100%; border-collapse: collapse;"> <thead> <tr> <th style="width: 15%; text-align: left;">AUTO 500</th> <th style="text-align: center;">Description</th> </tr> </thead> <tbody> <tr> <td></td> <td> <p>Each time a key is pressed, the frequency is incremented ( <span style="border: 1px solid black; padding: 2px;">MAN UP</span> Key) or decremented ( <span style="border: 1px solid black; padding: 2px;">MAN DWN</span> key ) one step. When the key is held down for more than 0.5 seconds, the seek operation ( seek up for <span style="border: 1px solid black; padding: 2px;">MAN UP</span> and seek down for <span style="border: 1px solid black; padding: 2px;">MAN DWN</span> ) starts at the point after 0.5 seconds. This seek operation is the same as that of the <span style="border: 1px solid black; padding: 2px;">SEEK UP</span> and <span style="border: 1px solid black; padding: 2px;">SEEK DWN</span> keys. After the key was held down for more than 0.5 seconds, the seek operation continues even if the key is released.</p> <p>Example 1) When key released within 0.5 seconds</p> <p>Example 2) When key held down for more than 0.5 seconds</p> <p>When the AUTO 500 switch was set to 1, do not use the <span style="border: 1px solid black; padding: 2px;">SEEK UP</span> and <span style="border: 1px solid black; padding: 2px;">SEEK DWN</span> keys.</p> </td> </tr> </tbody> </table> <p>• During clock display</p> <p>When the clock is displayed and the <span style="border: 1px solid black; padding: 2px;">ME</span> key was pressed and held, the minute and hour digits are adjusted by pressing the <span style="border: 1px solid black; padding: 2px;">MAN UP</span> and <span style="border: 1px solid black; padding: 2px;">MAN DWN</span> keys.</p> <p>For a description of the minute and hour digits adjustment method, see the <span style="border: 1px solid black; padding: 2px;">ME</span> key above.</p>	AUTO 500	Description		<p>Each time a key is pressed, the frequency is incremented ( <span style="border: 1px solid black; padding: 2px;">MAN UP</span> Key) or decremented ( <span style="border: 1px solid black; padding: 2px;">MAN DWN</span> key ) one step. When the key is held down for more than 0.5 seconds, the seek operation ( seek up for <span style="border: 1px solid black; padding: 2px;">MAN UP</span> and seek down for <span style="border: 1px solid black; padding: 2px;">MAN DWN</span> ) starts at the point after 0.5 seconds. This seek operation is the same as that of the <span style="border: 1px solid black; padding: 2px;">SEEK UP</span> and <span style="border: 1px solid black; padding: 2px;">SEEK DWN</span> keys. After the key was held down for more than 0.5 seconds, the seek operation continues even if the key is released.</p> <p>Example 1) When key released within 0.5 seconds</p> <p>Example 2) When key held down for more than 0.5 seconds</p> <p>When the AUTO 500 switch was set to 1, do not use the <span style="border: 1px solid black; padding: 2px;">SEEK UP</span> and <span style="border: 1px solid black; padding: 2px;">SEEK DWN</span> keys.</p>
AUTO 500	Description				
	<p>Each time a key is pressed, the frequency is incremented ( <span style="border: 1px solid black; padding: 2px;">MAN UP</span> Key) or decremented ( <span style="border: 1px solid black; padding: 2px;">MAN DWN</span> key ) one step. When the key is held down for more than 0.5 seconds, the seek operation ( seek up for <span style="border: 1px solid black; padding: 2px;">MAN UP</span> and seek down for <span style="border: 1px solid black; padding: 2px;">MAN DWN</span> ) starts at the point after 0.5 seconds. This seek operation is the same as that of the <span style="border: 1px solid black; padding: 2px;">SEEK UP</span> and <span style="border: 1px solid black; padding: 2px;">SEEK DWN</span> keys. After the key was held down for more than 0.5 seconds, the seek operation continues even if the key is released.</p> <p>Example 1) When key released within 0.5 seconds</p> <p>Example 2) When key held down for more than 0.5 seconds</p> <p>When the AUTO 500 switch was set to 1, do not use the <span style="border: 1px solid black; padding: 2px;">SEEK UP</span> and <span style="border: 1px solid black; padding: 2px;">SEEK DWN</span> keys.</p>				
<div style="border: 1px solid black; width: 50px; height: 20px; margin-bottom: 5px; text-align: center; line-height: 20px;">LOUD</div>	<p>LOUD (LOUDNESS) control key.</p> <p>It is valid in the radio, tape and CD modes.</p> <p>Each time this key is pressed, the LCD panel "LOUD" display and the LOUD pin (pin 19) output are inverted.</p> <p>The LOUD state is held even when radio, tape and CD mode switching is performed.</p> <p>When the power is turned on, the OFF state is set ("LOUD" display OFF, LOUD pin Low level).</p>				

Symbol	Function
<div style="border: 1px solid black; padding: 2px; width: fit-content; margin: 0 auto;">LOC (TP4)</div>	<p>In the radio mode, this key is used as the LOCAL (LOCAL/DX) control key. In the tape mode, this key is used as the tape function key by the initialized diode.</p> <p>- Radio mode</p> <p>This key is valid only when the initialized diode AUTOLOC switch is 0.</p> <p>Each time this key is pressed, the LCD panel LOC display and the LOC pin (pin 10) output are inverted.</p> <p>High level is output from the LOC pin while "LOC" is displayed.</p> <p>The FM, MW and LW bands common VF band is the same as the FM band.</p> <p>When the power is turned on, the OFF state ( "LOC" display off, LOC pin Low level) is set.</p> <p>- Tape mode</p> <p>When the initialized diode ENTPK switch is 1, this key is used as the AMS, NR (NOISE REDUCTION) or MTL (METAL) function key. For whether the AMS, NR or MTL function is selected, see the initialized diode KAMS, KNR and KMTL switches above.</p> <p>When the AMS, MTL or NR function key is selected, operation is the same as the <div style="border: 1px solid black; padding: 2px; display: inline-block; margin-left: 10px;">AMS</div></p> <p><div style="border: 1px solid black; padding: 2px; display: inline-block; margin-right: 5px;">MTL</div> and <div style="border: 1px solid black; padding: 2px; display: inline-block; margin-right: 5px;">NR</div> keys. See the description of each key.</p>
<div style="border: 1px solid black; padding: 2px; width: fit-content; margin: 0 auto;">MONO (TP5)</div>	<p>In the radio mode, this key is used as the MONO control key. In the tape mode, this key is used as the tape function key by the initialized diode.</p> <p>- Radio mode</p> <p>This key is valid only in FM and VF bands.</p> <p>Each time this key is pressed, the LCD panel "MONO" display and the MONO/NR<sub>2</sub> pin (pin 18) output the inverted. High level is output from the MONO/NR<sub>2</sub> pin while "MONO" is displayed.</p> <p>When the power is turned on, the OFF state is set ( "MONO" display OFF, MONO/NR<sub>2</sub> pin Low level).</p> <p>- Tape mode</p> <p>This key can be used as the AMS , MTL or NR function key by the initialized diode ENTPK, KAMS, KNR, and KMTL switches.</p> <p>See the ENTPK, KAMS and KMTL switches items.</p> <p>When the AMS or MTL function is selected, this key operates the same as the <div style="border: 1px solid black; padding: 2px; display: inline-block; margin-left: 10px;">MTL</div></p> <p><div style="border: 1px solid black; padding: 2px; display: inline-block; margin-right: 5px;">AMS</div> or <div style="border: 1px solid black; padding: 2px; display: inline-block; margin-right: 5px;">NR</div> key. See the description of each key.</p> <p>In the radio monitor and DK ON modes, this key operates as the MONO control key.</p>
<div style="border: 1px solid black; padding: 2px; width: fit-content; margin: 0 auto;">MTL</div>	<p>MTL ( METAL ) control key.</p> <p>This key is valid in the tape mode.</p> <p>Each time this key is pressed, the LCD panel "MTL" display and the MTL pin (pin 21) output are inverted.</p> <p>High level is output from the LOC/MTL pin while "MTL" is displayed.</p> <p>When the power is turned on, the OFF state is set ( " MTL" display OFF, MTL pin Low level).</p>

Symbol	Function															
NR	<p>NR<sub>1</sub> (NOISE REDUCTION) and NR<sub>2</sub> control key.                      This key is valid in the tape mode.                      Its operation depends on the setting of the initialized diode ENNR<sub>2</sub> switch as shown below.</p> <table border="1" style="width: 100%; border-collapse: collapse;"> <thead> <tr> <th style="width: 15%;">ENNR<sub>2</sub></th> <th style="text-align: center;">Key Operation</th> </tr> </thead> <tbody> <tr> <td style="text-align: center;">0</td> <td> <p>Each time this key is pressed, the LCD panel "NR<sub>1</sub>" display and the NR<sub>1</sub> pin (pin 22) output are inverted.                              High level is output from the NR<sub>1</sub> pin while "NR<sub>1</sub>" is displayed.                              When the power is turned on, the OFF state is set ("NR<sub>1</sub>" display OFF, NR<sub>1</sub> pin Low level).</p> </td> </tr> <tr> <td style="text-align: center;">1</td> <td> <p>Each time this key is pressed, the display and output are switched as shown below.</p> <div style="text-align: center;"> <table style="width: 100%; border: none;"> <tr> <td style="width: 50%; border: none;">                             "NR<sub>1</sub>" display OFF                              NR<sub>1</sub> pin Low                              "NR<sub>2</sub>" display OFF                              MONO/NR<sub>2</sub> pin LOW                         </td> <td style="width: 10%; border: none; text-align: center;">                             →                         </td> <td style="width: 40%; border: none;">                             "NR<sub>1</sub>" display ON                              NR<sub>1</sub> pin High                              "NR<sub>2</sub>" display OFF                              MONO/NR<sub>2</sub> pin LOW                         </td> </tr> <tr> <td style="border: none;"></td> <td style="border: none; text-align: center;">                             ←                         </td> <td style="border: none;"></td> </tr> <tr> <td style="border: none;"></td> <td style="border: none; text-align: center;">                             "NR<sub>1</sub>" display ON                              NR<sub>1</sub> pin LOW                              "NR<sub>2</sub>" display ON                              MONO/NR<sub>2</sub> pin HIGH                         </td> <td style="border: none;"></td> </tr> </table> </div> <p>When the power is turned on, NR<sub>1</sub> and NR<sub>2</sub> are both turned off.</p> </td> </tr> </tbody> </table>	ENNR <sub>2</sub>	Key Operation	0	<p>Each time this key is pressed, the LCD panel "NR<sub>1</sub>" display and the NR<sub>1</sub> pin (pin 22) output are inverted.                              High level is output from the NR<sub>1</sub> pin while "NR<sub>1</sub>" is displayed.                              When the power is turned on, the OFF state is set ("NR<sub>1</sub>" display OFF, NR<sub>1</sub> pin Low level).</p>	1	<p>Each time this key is pressed, the display and output are switched as shown below.</p> <div style="text-align: center;"> <table style="width: 100%; border: none;"> <tr> <td style="width: 50%; border: none;">                             "NR<sub>1</sub>" display OFF                              NR<sub>1</sub> pin Low                              "NR<sub>2</sub>" display OFF                              MONO/NR<sub>2</sub> pin LOW                         </td> <td style="width: 10%; border: none; text-align: center;">                             →                         </td> <td style="width: 40%; border: none;">                             "NR<sub>1</sub>" display ON                              NR<sub>1</sub> pin High                              "NR<sub>2</sub>" display OFF                              MONO/NR<sub>2</sub> pin LOW                         </td> </tr> <tr> <td style="border: none;"></td> <td style="border: none; text-align: center;">                             ←                         </td> <td style="border: none;"></td> </tr> <tr> <td style="border: none;"></td> <td style="border: none; text-align: center;">                             "NR<sub>1</sub>" display ON                              NR<sub>1</sub> pin LOW                              "NR<sub>2</sub>" display ON                              MONO/NR<sub>2</sub> pin HIGH                         </td> <td style="border: none;"></td> </tr> </table> </div> <p>When the power is turned on, NR<sub>1</sub> and NR<sub>2</sub> are both turned off.</p>	"NR <sub>1</sub> " display OFF NR <sub>1</sub> pin Low "NR <sub>2</sub> " display OFF MONO/NR <sub>2</sub> pin LOW	→	"NR <sub>1</sub> " display ON NR <sub>1</sub> pin High "NR <sub>2</sub> " display OFF MONO/NR <sub>2</sub> pin LOW		←			"NR <sub>1</sub> " display ON NR <sub>1</sub> pin LOW "NR <sub>2</sub> " display ON MONO/NR <sub>2</sub> pin HIGH	
ENNR <sub>2</sub>	Key Operation															
0	<p>Each time this key is pressed, the LCD panel "NR<sub>1</sub>" display and the NR<sub>1</sub> pin (pin 22) output are inverted.                              High level is output from the NR<sub>1</sub> pin while "NR<sub>1</sub>" is displayed.                              When the power is turned on, the OFF state is set ("NR<sub>1</sub>" display OFF, NR<sub>1</sub> pin Low level).</p>															
1	<p>Each time this key is pressed, the display and output are switched as shown below.</p> <div style="text-align: center;"> <table style="width: 100%; border: none;"> <tr> <td style="width: 50%; border: none;">                             "NR<sub>1</sub>" display OFF                              NR<sub>1</sub> pin Low                              "NR<sub>2</sub>" display OFF                              MONO/NR<sub>2</sub> pin LOW                         </td> <td style="width: 10%; border: none; text-align: center;">                             →                         </td> <td style="width: 40%; border: none;">                             "NR<sub>1</sub>" display ON                              NR<sub>1</sub> pin High                              "NR<sub>2</sub>" display OFF                              MONO/NR<sub>2</sub> pin LOW                         </td> </tr> <tr> <td style="border: none;"></td> <td style="border: none; text-align: center;">                             ←                         </td> <td style="border: none;"></td> </tr> <tr> <td style="border: none;"></td> <td style="border: none; text-align: center;">                             "NR<sub>1</sub>" display ON                              NR<sub>1</sub> pin LOW                              "NR<sub>2</sub>" display ON                              MONO/NR<sub>2</sub> pin HIGH                         </td> <td style="border: none;"></td> </tr> </table> </div> <p>When the power is turned on, NR<sub>1</sub> and NR<sub>2</sub> are both turned off.</p>	"NR <sub>1</sub> " display OFF NR <sub>1</sub> pin Low "NR <sub>2</sub> " display OFF MONO/NR <sub>2</sub> pin LOW	→	"NR <sub>1</sub> " display ON NR <sub>1</sub> pin High "NR <sub>2</sub> " display OFF MONO/NR <sub>2</sub> pin LOW		←			"NR <sub>1</sub> " display ON NR <sub>1</sub> pin LOW "NR <sub>2</sub> " display ON MONO/NR <sub>2</sub> pin HIGH							
"NR <sub>1</sub> " display OFF NR <sub>1</sub> pin Low "NR <sub>2</sub> " display OFF MONO/NR <sub>2</sub> pin LOW	→	"NR <sub>1</sub> " display ON NR <sub>1</sub> pin High "NR <sub>2</sub> " display OFF MONO/NR <sub>2</sub> pin LOW														
	←															
	"NR <sub>1</sub> " display ON NR <sub>1</sub> pin LOW "NR <sub>2</sub> " display ON MONO/NR <sub>2</sub> pin HIGH															
AMS	<p>AMS (AUTO MUSIC SEARCH) control key.                      This key is valid in the tape mode.                      Each time this key is pressed, the LCD panel "AMS" display and the AMS pin (pin 20) output are inverted. High level is output from the AMS pin while "AMS" is displayed.                      When the AMS pin is high level (AMS mode), if the TPSET switch is ON, the AMS pin holds the high level output even if the mode is switched to the CD or radio mode.                      When the power is turned on, AMS is turned off ("AMS" display OFF, AMS pin Low level).</p>															
RDMONI	<p>Radio monitor key.                      This key is valid in the tape and CD modes.                      Each time this key is pressed, the radio monitor mode is inverted. In the radio monitor mode, the LCD panel "RDMONI" display lights.                      In the radio monitor mode, all band tuning operations are possible and radio muting (RDMUTE pin) is turned off and audio muting (AMUTE pin) is turned on.</p>															

Symbol	Function																																
<div style="border: 1px solid black; padding: 2px; width: fit-content; margin-bottom: 10px;">DISP</div>	<p>Display switching key.</p> <p>This key is valid when the initialized diode NOCLK = 0 (clock), M2S = 0</p> <p>The display switching operation is shown below.</p> <ul style="list-style-type: none"> <li>● Radio mode</li> </ul> <p>Each time this key is pressed, the frequency display and clock display are switched.</p> <p>This key is invalid at seek, scan and auto preset scan.</p> <p>Operation according to the setting of the initialized diode PRIO1 and PRIO 2 switches is shown below.</p> <table border="1" style="width: 100%; border-collapse: collapse; margin-bottom: 10px;"> <thead> <tr> <th style="width: 10%;">PRIO1</th> <th style="width: 10%;">PRIO2</th> <th style="width: 15%;">Priority Display</th> <th style="width: 65%;">Description</th> </tr> </thead> <tbody> <tr> <td style="text-align: center;">0</td> <td style="text-align: center;">0</td> <td style="text-align: center;">None</td> <td>Each time the <span style="border: 1px solid black; padding: 0 5px;">DISP</span> key is pressed, the frequency display and clock display are switched.</td> </tr> <tr> <td style="text-align: center;">0</td> <td style="text-align: center;">1</td> <td style="text-align: center;">Frequency display</td> <td>When the <span style="border: 1px solid black; padding: 0 5px;">DISP</span> key is pressed during frequency display, the clock is displayed for 5 seconds. When the <span style="border: 1px solid black; padding: 0 5px;">DISP</span> key is pressed during the 5 seconds clock display, the display returns to the frequency display.</td> </tr> <tr> <td style="text-align: center;">1</td> <td style="text-align: center;">0</td> <td style="text-align: center;">Clock display</td> <td>When the <span style="border: 1px solid black; padding: 0 5px;">DISP</span> key is pressed during clock display, the frequency display is displayed for 5 seconds. When the <span style="border: 1px solid black; padding: 0 5px;">DISP</span> key is pressed during the 5 seconds frequency display, the display returns to the clock display.</td> </tr> </tbody> </table> <p>When the device is switched to the radio mode, display starts from frequency display.</p> <ul style="list-style-type: none"> <li>● Tape mode</li> </ul> <p>The <span style="border: 1px solid black; padding: 0 5px;">DISP</span> Key is invalid.</p> <ul style="list-style-type: none"> <li>● CD mode</li> </ul> <p>Each time this key is pressed, the <span style="border: 1px solid black; padding: 0 5px;">CD</span> display and clock display are switched.</p> <p>Operation according to the setting of the initialized diodes PRIO1 and PRIO2 is shown below.</p> <table border="1" style="width: 100%; border-collapse: collapse; margin-bottom: 10px;"> <thead> <tr> <th style="width: 10%;">PRIO1</th> <th style="width: 10%;">PRIO2</th> <th style="width: 15%;">Priority Display</th> <th style="width: 65%;">Description</th> </tr> </thead> <tbody> <tr> <td style="text-align: center;">0</td> <td style="text-align: center;">0</td> <td style="text-align: center;">None</td> <td>Each time the <span style="border: 1px solid black; padding: 0 5px;">DISP</span> key is pressed, the <span style="border: 1px solid black; padding: 0 5px;">CD</span> display and clock display are switched.</td> </tr> <tr> <td style="text-align: center;">0</td> <td style="text-align: center;">1</td> <td style="text-align: center;"><span style="border: 1px solid black; padding: 0 5px;">CD</span> display</td> <td>When the <span style="border: 1px solid black; padding: 0 5px;">DISP</span> key is pressed, during <span style="border: 1px solid black; padding: 0 5px;">CD</span> display, the clock is displayed for 5 seconds. When the <span style="border: 1px solid black; padding: 0 5px;">DISP</span> key is pressed during the 5 seconds clock display, the display returns to the <span style="border: 1px solid black; padding: 0 5px;">CD</span> display.</td> </tr> <tr> <td style="text-align: center;">1</td> <td style="text-align: center;">0</td> <td style="text-align: center;">Clock</td> <td>When the <span style="border: 1px solid black; padding: 0 5px;">DISP</span> key is pressed during clock display, the <span style="border: 1px solid black; padding: 0 5px;">CD</span> display is displayed for 5 seconds. When the <span style="border: 1px solid black; padding: 0 5px;">DISP</span> key is pressed during the 5 seconds <span style="border: 1px solid black; padding: 0 5px;">CD</span> display, the display returns to the <span style="border: 1px solid black; padding: 0 5px;">CD</span> display.</td> </tr> </tbody> </table> <p>When the device is switched to the CD mode, display starts from <span style="border: 1px solid black; padding: 0 5px;">CD</span> display.</p>	PRIO1	PRIO2	Priority Display	Description	0	0	None	Each time the <span style="border: 1px solid black; padding: 0 5px;">DISP</span> key is pressed, the frequency display and clock display are switched.	0	1	Frequency display	When the <span style="border: 1px solid black; padding: 0 5px;">DISP</span> key is pressed during frequency display, the clock is displayed for 5 seconds. When the <span style="border: 1px solid black; padding: 0 5px;">DISP</span> key is pressed during the 5 seconds clock display, the display returns to the frequency display.	1	0	Clock display	When the <span style="border: 1px solid black; padding: 0 5px;">DISP</span> key is pressed during clock display, the frequency display is displayed for 5 seconds. When the <span style="border: 1px solid black; padding: 0 5px;">DISP</span> key is pressed during the 5 seconds frequency display, the display returns to the clock display.	PRIO1	PRIO2	Priority Display	Description	0	0	None	Each time the <span style="border: 1px solid black; padding: 0 5px;">DISP</span> key is pressed, the <span style="border: 1px solid black; padding: 0 5px;">CD</span> display and clock display are switched.	0	1	<span style="border: 1px solid black; padding: 0 5px;">CD</span> display	When the <span style="border: 1px solid black; padding: 0 5px;">DISP</span> key is pressed, during <span style="border: 1px solid black; padding: 0 5px;">CD</span> display, the clock is displayed for 5 seconds. When the <span style="border: 1px solid black; padding: 0 5px;">DISP</span> key is pressed during the 5 seconds clock display, the display returns to the <span style="border: 1px solid black; padding: 0 5px;">CD</span> display.	1	0	Clock	When the <span style="border: 1px solid black; padding: 0 5px;">DISP</span> key is pressed during clock display, the <span style="border: 1px solid black; padding: 0 5px;">CD</span> display is displayed for 5 seconds. When the <span style="border: 1px solid black; padding: 0 5px;">DISP</span> key is pressed during the 5 seconds <span style="border: 1px solid black; padding: 0 5px;">CD</span> display, the display returns to the <span style="border: 1px solid black; padding: 0 5px;">CD</span> display.
PRIO1	PRIO2	Priority Display	Description																														
0	0	None	Each time the <span style="border: 1px solid black; padding: 0 5px;">DISP</span> key is pressed, the frequency display and clock display are switched.																														
0	1	Frequency display	When the <span style="border: 1px solid black; padding: 0 5px;">DISP</span> key is pressed during frequency display, the clock is displayed for 5 seconds. When the <span style="border: 1px solid black; padding: 0 5px;">DISP</span> key is pressed during the 5 seconds clock display, the display returns to the frequency display.																														
1	0	Clock display	When the <span style="border: 1px solid black; padding: 0 5px;">DISP</span> key is pressed during clock display, the frequency display is displayed for 5 seconds. When the <span style="border: 1px solid black; padding: 0 5px;">DISP</span> key is pressed during the 5 seconds frequency display, the display returns to the clock display.																														
PRIO1	PRIO2	Priority Display	Description																														
0	0	None	Each time the <span style="border: 1px solid black; padding: 0 5px;">DISP</span> key is pressed, the <span style="border: 1px solid black; padding: 0 5px;">CD</span> display and clock display are switched.																														
0	1	<span style="border: 1px solid black; padding: 0 5px;">CD</span> display	When the <span style="border: 1px solid black; padding: 0 5px;">DISP</span> key is pressed, during <span style="border: 1px solid black; padding: 0 5px;">CD</span> display, the clock is displayed for 5 seconds. When the <span style="border: 1px solid black; padding: 0 5px;">DISP</span> key is pressed during the 5 seconds clock display, the display returns to the <span style="border: 1px solid black; padding: 0 5px;">CD</span> display.																														
1	0	Clock	When the <span style="border: 1px solid black; padding: 0 5px;">DISP</span> key is pressed during clock display, the <span style="border: 1px solid black; padding: 0 5px;">CD</span> display is displayed for 5 seconds. When the <span style="border: 1px solid black; padding: 0 5px;">DISP</span> key is pressed during the 5 seconds <span style="border: 1px solid black; padding: 0 5px;">CD</span> display, the display returns to the <span style="border: 1px solid black; padding: 0 5px;">CD</span> display.																														

Symbol	Function
<div data-bbox="66 349 177 383" style="border: 1px solid black; padding: 2px; width: fit-content;">POWER</div>	<p>This key is used when turning the radio ON and OFF momentary key, controlling the illumination, etc.</p> <p>This key is valid only when the CE pin is High.</p> <p>The POWER pin (pin 23) output is inverted by pressing this key.</p> <p>When using this key, set the RDON switch (diode matrix) to 0.</p> <p>The radio is turned on and off by turning the transistor switch RDON ON and OFF with the output of the POWER pin.</p> <p>For details, see "Mode Transition" and "Application Circuits".</p>

## 2.4.2 Alternate or Transistor Switch

Symbol	Function													
CDSET	<p>CD mode setting switch.</p> <p>This switch is valid only when the CE pin is high level.</p> <p>The CD mode can be set by setting this switch to ON.</p> <p>For details, see "Mode Transition".</p>													
TPSET	<p>Tape mode setting switch.</p> <p>This switch is valid only when the CE pin is high level.</p> <p>When this switch is set to ON when the CDSET is OFF, the device is set to the tape mode.</p> <p>For details, see "Mode Transition".</p>													
RDSET	<p>Radio mode setting switch.</p> <p>This switch is valid only when the CE pin is high level.</p> <p>When this switch is set to ON when the CDSET and TPSET switches are OFF, the device is set to the radio mode.</p> <p>For details, see "Mode Transition".</p> <p>When using this switch, set the RDON switch (diode matrix) to 0.</p>													
FF	<p>Tape mode fast forward signal input switch.</p> <p>The tape fast forward display (&lt;D&gt;) lights as shown below according to the state of the RL switch.</p> <table border="1" style="margin: 10px auto; border-collapse: collapse;"> <thead> <tr> <th style="width: 10%;">FF</th> <th style="width: 10%;">RL</th> <th style="width: 80%;">Display</th> </tr> </thead> <tbody> <tr> <td rowspan="2" style="text-align: center;">0</td> <td style="text-align: center;">0</td> <td style="text-align: center;">◀</td> </tr> <tr> <td style="text-align: center;">1</td> <td style="text-align: center;">▶</td> </tr> <tr> <td rowspan="2" style="text-align: center;">1</td> <td style="text-align: center;">0</td> <td style="text-align: center;">◁</td> </tr> <tr> <td style="text-align: center;">1</td> <td style="text-align: center;">▷</td> </tr> </tbody> </table> <p>◀ : Light ON, ◁ : Flash (2Hz)</p> <p>0 : OFF, 1 : ON</p>	FF	RL	Display	0	0	◀	1	▶	1	0	◁	1	▷
FF	RL	Display												
0	0	◀												
	1	▶												
1	0	◁												
	1	▷												
SK	<p>VF broadcast station SK signal input switch.</p> <p>When this switch is set to ON on the FM and VF bands, the LCD panel "SK" display lights. On the FM and VF bands this signal is also used as the auto tuning stop signal. At this time, 250 to 375 ms after the broadcast station is judged to be present by IF and SD pin, this switch is checked and if it is ON, a traffic information station is judged to be present and autotuning stops.</p>													
RL	<p>Tape mode travel direction signal input switch.</p> <p>The tape display (&lt;D&gt;) lights according to the state of the FF switch. For the lighting contents, see the FF switch above.</p>													
DK	<p>VF broadcast station DK signal input switch.</p> <p>When this switch is set to ON in the tape DK standby and CD DK standby modes, the device enters the tape DK ON and CD DK ON mode.</p>													

## 2.4.3 Diode Matrix

Symbol	Function																																															
<p>AREA1 AREA2 AREA3</p>	<p>Receiving area setting switch. Its setting is shown below. For the receiving frequencies, etc, at each area, see page 2.</p> <table border="1" style="margin-left: auto; margin-right: auto; border-collapse: collapse;"> <thead> <tr> <th style="width: 15%;">AREA3</th> <th style="width: 15%;">AREA 2</th> <th style="width: 15%;">AREA 1</th> <th style="width: 55%;">MODE</th> </tr> </thead> <tbody> <tr><td style="text-align: center;">0</td><td style="text-align: center;">0</td><td style="text-align: center;">0</td><td>Europe1</td></tr> <tr><td style="text-align: center;">0</td><td style="text-align: center;">0</td><td style="text-align: center;">1</td><td>Europe 2</td></tr> <tr><td style="text-align: center;">0</td><td style="text-align: center;">1</td><td style="text-align: center;">0</td><td>U.S.A 1</td></tr> <tr><td style="text-align: center;">0</td><td style="text-align: center;">1</td><td style="text-align: center;">1</td><td>U.S.A 2</td></tr> <tr><td style="text-align: center;">1</td><td style="text-align: center;">0</td><td style="text-align: center;">0</td><td>U.S.A 3</td></tr> <tr><td style="text-align: center;">1</td><td style="text-align: center;">0</td><td style="text-align: center;">1</td><td>Australia, Middle East</td></tr> <tr><td style="text-align: center;">1</td><td style="text-align: center;">1</td><td style="text-align: center;">0</td><td>Japan</td></tr> <tr><td style="text-align: center;">1</td><td style="text-align: center;">1</td><td style="text-align: center;">1</td><td>Central and South America</td></tr> </tbody> </table>	AREA3	AREA 2	AREA 1	MODE	0	0	0	Europe1	0	0	1	Europe 2	0	1	0	U.S.A 1	0	1	1	U.S.A 2	1	0	0	U.S.A 3	1	0	1	Australia, Middle East	1	1	0	Japan	1	1	1	Central and South America											
AREA3	AREA 2	AREA 1	MODE																																													
0	0	0	Europe1																																													
0	0	1	Europe 2																																													
0	1	0	U.S.A 1																																													
0	1	1	U.S.A 2																																													
1	0	0	U.S.A 3																																													
1	0	1	Australia, Middle East																																													
1	1	0	Japan																																													
1	1	1	Central and South America																																													
<p>DISFM3 ENMW2 DISLW</p>	<p>Receiving band setting switch. Its setting is shown below</p> <ul style="list-style-type: none"> <li>• DISFM3 ..... FM3 band is disabled by setting to 1.</li> <li>• ENMW2..... MW2 band is enabled by setting to 1.</li> <li>• DISLW..... In Europe, the LW band is disabled by setting to 1.</li> </ul> <p style="text-align: center;">The DISLW switch is invalid in areas outside of Europe.</p> <p>The receiving bands for each area are set with these switches as shown below.</p> <table border="1" style="margin-left: auto; margin-right: auto; border-collapse: collapse;"> <thead> <tr> <th style="width: 10%;">AREA</th> <th style="width: 10%;">DISFM3</th> <th style="width: 10%;">ENMW2</th> <th style="width: 10%;">DISLW</th> <th style="width: 60%;">Receiving Bands</th> </tr> </thead> <tbody> <tr> <td rowspan="6" style="text-align: center; vertical-align: middle;">Europe1, Europe 2</td> <td style="text-align: center;">0</td> <td style="text-align: center;">0</td> <td style="text-align: center;">0</td> <td>FM1, FM2, FM3, MW1, LW</td> </tr> <tr> <td style="text-align: center;">0</td> <td style="text-align: center;">0</td> <td style="text-align: center;">1</td> <td>FM1, FM2, FM3, MW1</td> </tr> <tr> <td style="text-align: center;">0</td> <td style="text-align: center;">1</td> <td style="text-align: center;">—</td> <td>FM1, FM2, FM3, MW1, MW2</td> </tr> <tr> <td style="text-align: center;">1</td> <td style="text-align: center;">0</td> <td style="text-align: center;">0</td> <td>FM1, FM2, MW1, LW</td> </tr> <tr> <td style="text-align: center;">1</td> <td style="text-align: center;">0</td> <td style="text-align: center;">1</td> <td>FM1, FM2, MW1</td> </tr> <tr> <td style="text-align: center;">1</td> <td style="text-align: center;">1</td> <td style="text-align: center;">—</td> <td>FM1, FM2, MW1, MW2</td> </tr> <tr> <td rowspan="4" style="text-align: center; vertical-align: middle;">Other areas</td> <td style="text-align: center;">0</td> <td style="text-align: center;">0</td> <td style="text-align: center;">—</td> <td>FM1, FM2, FM3, MW1</td> </tr> <tr> <td style="text-align: center;">0</td> <td style="text-align: center;">1</td> <td style="text-align: center;">—</td> <td>FM1, FM2, FM3, MW1, MW2</td> </tr> <tr> <td style="text-align: center;">1</td> <td style="text-align: center;">0</td> <td style="text-align: center;">—</td> <td>FM1, FM2, MW1</td> </tr> <tr> <td style="text-align: center;">1</td> <td style="text-align: center;">1</td> <td style="text-align: center;">—</td> <td>FM1, FM2, MW1, MW2</td> </tr> </tbody> </table> <p style="text-align: right; margin-top: 10px;">— : Don't care</p>	AREA	DISFM3	ENMW2	DISLW	Receiving Bands	Europe1, Europe 2	0	0	0	FM1, FM2, FM3, MW1, LW	0	0	1	FM1, FM2, FM3, MW1	0	1	—	FM1, FM2, FM3, MW1, MW2	1	0	0	FM1, FM2, MW1, LW	1	0	1	FM1, FM2, MW1	1	1	—	FM1, FM2, MW1, MW2	Other areas	0	0	—	FM1, FM2, FM3, MW1	0	1	—	FM1, FM2, FM3, MW1, MW2	1	0	—	FM1, FM2, MW1	1	1	—	FM1, FM2, MW1, MW2
AREA	DISFM3	ENMW2	DISLW	Receiving Bands																																												
Europe1, Europe 2	0	0	0	FM1, FM2, FM3, MW1, LW																																												
	0	0	1	FM1, FM2, FM3, MW1																																												
	0	1	—	FM1, FM2, FM3, MW1, MW2																																												
	1	0	0	FM1, FM2, MW1, LW																																												
	1	0	1	FM1, FM2, MW1																																												
	1	1	—	FM1, FM2, MW1, MW2																																												
Other areas	0	0	—	FM1, FM2, FM3, MW1																																												
	0	1	—	FM1, FM2, FM3, MW1, MW2																																												
	1	0	—	FM1, FM2, MW1																																												
	1	1	—	FM1, FM2, MW1, MW2																																												

Symbol	Function						
M2S	<p>Preset memory write method setting switch. Its setting is shown below.</p> <table border="1" style="width: 100%; border-collapse: collapse; margin: 10px 0;"> <thead> <tr> <th style="width: 10%; text-align: center;">M2S</th> <th style="text-align: center;">Write Method</th> </tr> </thead> <tbody> <tr> <td style="text-align: center;">0</td> <td>                     Preset memory is written by pressing a <span style="border: 1px solid black; padding: 2px;">M1 (TP1)</span> to <span style="border: 1px solid black; padding: 2px;">M6</span> key in the 5 seconds memory write state by <span style="border: 1px solid black; padding: 2px;">ME</span> key.                 </td> </tr> <tr> <td style="text-align: center;">1</td> <td>                     Preset memory is written by holding down a <span style="border: 1px solid black; padding: 2px;">M1 (TP1)</span> to <span style="border: 1px solid black; padding: 2px;">M6</span> key for more than 2 seconds. The <span style="border: 1px solid black; padding: 2px;">ME</span> key is invalid.                 </td> </tr> </tbody> </table> <p>For more information, see the <span style="border: 1px solid black; padding: 2px;">ME</span> and <span style="border: 1px solid black; padding: 2px;">M1 (TP1)</span> to <span style="border: 1px solid black; padding: 2px;">M6</span> items.</p>	M2S	Write Method	0	Preset memory is written by pressing a <span style="border: 1px solid black; padding: 2px;">M1 (TP1)</span> to <span style="border: 1px solid black; padding: 2px;">M6</span> key in the 5 seconds memory write state by <span style="border: 1px solid black; padding: 2px;">ME</span> key.	1	Preset memory is written by holding down a <span style="border: 1px solid black; padding: 2px;">M1 (TP1)</span> to <span style="border: 1px solid black; padding: 2px;">M6</span> key for more than 2 seconds. The <span style="border: 1px solid black; padding: 2px;">ME</span> key is invalid.
M2S	Write Method						
0	Preset memory is written by pressing a <span style="border: 1px solid black; padding: 2px;">M1 (TP1)</span> to <span style="border: 1px solid black; padding: 2px;">M6</span> key in the 5 seconds memory write state by <span style="border: 1px solid black; padding: 2px;">ME</span> key.						
1	Preset memory is written by holding down a <span style="border: 1px solid black; padding: 2px;">M1 (TP1)</span> to <span style="border: 1px solid black; padding: 2px;">M6</span> key for more than 2 seconds. The <span style="border: 1px solid black; padding: 2px;">ME</span> key is invalid.						
AUTO 500	<p><span style="border: 1px solid black; padding: 2px;">MAN UP</span> and <span style="border: 1px solid black; padding: 2px;">MAN DWN</span> keys function setting switch. The <span style="border: 1px solid black; padding: 2px;">MAN UP</span> and <span style="border: 1px solid black; padding: 2px;">MAN DWN</span> keys can also be used as autotuning (seek operation) keys by means of this switch. The settings of this switch are shown below.</p> <table border="1" style="width: 100%; border-collapse: collapse; margin: 10px 0;"> <thead> <tr> <th style="width: 15%; text-align: center;">AUTO 500</th> <th style="text-align: center;">Key Function</th> </tr> </thead> <tbody> <tr> <td style="text-align: center;">0</td> <td>                     Manual tuning only. Each time the key is pressed, the channel is incremented or decremented by one. When the key is held down for more than 0.5 seconds, the channel is changed continuously and rapidly.                 </td> </tr> <tr> <td style="text-align: center;">1</td> <td>                     Manual tuning and autotuning. Each time the key is pressed, the channel is incremented or decremented by one. When the key is held down for more than 0.5 seconds, autotuning (seek operation) is performed from the next channel.                 </td> </tr> </tbody> </table>	AUTO 500	Key Function	0	Manual tuning only. Each time the key is pressed, the channel is incremented or decremented by one. When the key is held down for more than 0.5 seconds, the channel is changed continuously and rapidly.	1	Manual tuning and autotuning. Each time the key is pressed, the channel is incremented or decremented by one. When the key is held down for more than 0.5 seconds, autotuning (seek operation) is performed from the next channel.
AUTO 500	Key Function						
0	Manual tuning only. Each time the key is pressed, the channel is incremented or decremented by one. When the key is held down for more than 0.5 seconds, the channel is changed continuously and rapidly.						
1	Manual tuning and autotuning. Each time the key is pressed, the channel is incremented or decremented by one. When the key is held down for more than 0.5 seconds, autotuning (seek operation) is performed from the next channel.						



# DMC 4001

Symbol	Function						
AUTOLOC	<p>Local function setting switch. Its setting is shown below.</p> <table border="1" style="width: 100%; border-collapse: collapse;"> <thead> <tr> <th style="width: 15%; text-align: center;">AUTOLOC</th> <th style="text-align: center;">Local Function</th> </tr> </thead> <tbody> <tr> <td style="text-align: center; vertical-align: top;">0</td> <td> <p>LOCAL ON/OFF by key input. Each time the <input type="button" value="LOC"/> key pressed, the "LOC" display is inverted. LOCAL output is high level only during autotuning (SEEK, SCAN, AMEMO).</p> </td> </tr> <tr> <td style="text-align: center; vertical-align: top;">1</td> <td> <p>The <input type="button" value="LOC"/> key is invalid. When autotuning is selected by <input type="button" value="SEEK UP"/> , <input type="button" value="SEEK DWN"/> , <input type="button" value="SCAN UP"/> , <input type="button" value="SCAN DWN"/> , <input type="button" value="AMEMO"/> keys, the "LOC" display lights and the LOCAL output becomes high and autotuning is performed. When autotuning is performed for one cycle, the device searches in the DX mode ( "LOC" display OFF, LOCAL output = Low). However, the device enters the LOCAL1, LOCAL2 or DX mode only during auto memory operation. At other than autotuning, the "LOC" display goes off and the LOCAL output becomes low. If the same key ( <input type="button" value="SEEK UP"/> key for the seek up operation, etc) is pressed during autotuning, if the device is in the LOCAL mode, it searches in the DX mode, beginning from the frequency at which autotuning started. If the device is in the DX mode, autotuning stops. When AUTO500 switch is set to "1" ( autotuning by pressing <input type="button" value="MAN UP"/> or <input type="button" value="MAN DWN"/> key for 0.5 second ) when auto local is used, the following operations are performed. Auto local search (LOCAL) mode is performed by pressing the <input type="button" value="MAN UP"/> or <input type="button" value="MAN DWN"/> key for more than 0.5 seconds. When the <input type="button" value="MAN UP"/> or <input type="button" value="MAN DWN"/> key is pressed again during LOCAL search and the 2nd DX search, autotuning stops.</p> </td> </tr> </tbody> </table>	AUTOLOC	Local Function	0	<p>LOCAL ON/OFF by key input. Each time the <input type="button" value="LOC"/> key pressed, the "LOC" display is inverted. LOCAL output is high level only during autotuning (SEEK, SCAN, AMEMO).</p>	1	<p>The <input type="button" value="LOC"/> key is invalid. When autotuning is selected by <input type="button" value="SEEK UP"/> , <input type="button" value="SEEK DWN"/> , <input type="button" value="SCAN UP"/> , <input type="button" value="SCAN DWN"/> , <input type="button" value="AMEMO"/> keys, the "LOC" display lights and the LOCAL output becomes high and autotuning is performed. When autotuning is performed for one cycle, the device searches in the DX mode ( "LOC" display OFF, LOCAL output = Low). However, the device enters the LOCAL1, LOCAL2 or DX mode only during auto memory operation. At other than autotuning, the "LOC" display goes off and the LOCAL output becomes low. If the same key ( <input type="button" value="SEEK UP"/> key for the seek up operation, etc) is pressed during autotuning, if the device is in the LOCAL mode, it searches in the DX mode, beginning from the frequency at which autotuning started. If the device is in the DX mode, autotuning stops. When AUTO500 switch is set to "1" ( autotuning by pressing <input type="button" value="MAN UP"/> or <input type="button" value="MAN DWN"/> key for 0.5 second ) when auto local is used, the following operations are performed. Auto local search (LOCAL) mode is performed by pressing the <input type="button" value="MAN UP"/> or <input type="button" value="MAN DWN"/> key for more than 0.5 seconds. When the <input type="button" value="MAN UP"/> or <input type="button" value="MAN DWN"/> key is pressed again during LOCAL search and the 2nd DX search, autotuning stops.</p>
	AUTOLOC	Local Function					
0	<p>LOCAL ON/OFF by key input. Each time the <input type="button" value="LOC"/> key pressed, the "LOC" display is inverted. LOCAL output is high level only during autotuning (SEEK, SCAN, AMEMO).</p>						
1	<p>The <input type="button" value="LOC"/> key is invalid. When autotuning is selected by <input type="button" value="SEEK UP"/> , <input type="button" value="SEEK DWN"/> , <input type="button" value="SCAN UP"/> , <input type="button" value="SCAN DWN"/> , <input type="button" value="AMEMO"/> keys, the "LOC" display lights and the LOCAL output becomes high and autotuning is performed. When autotuning is performed for one cycle, the device searches in the DX mode ( "LOC" display OFF, LOCAL output = Low). However, the device enters the LOCAL1, LOCAL2 or DX mode only during auto memory operation. At other than autotuning, the "LOC" display goes off and the LOCAL output becomes low. If the same key ( <input type="button" value="SEEK UP"/> key for the seek up operation, etc) is pressed during autotuning, if the device is in the LOCAL mode, it searches in the DX mode, beginning from the frequency at which autotuning started. If the device is in the DX mode, autotuning stops. When AUTO500 switch is set to "1" ( autotuning by pressing <input type="button" value="MAN UP"/> or <input type="button" value="MAN DWN"/> key for 0.5 second ) when auto local is used, the following operations are performed. Auto local search (LOCAL) mode is performed by pressing the <input type="button" value="MAN UP"/> or <input type="button" value="MAN DWN"/> key for more than 0.5 seconds. When the <input type="button" value="MAN UP"/> or <input type="button" value="MAN DWN"/> key is pressed again during LOCAL search and the 2nd DX search, autotuning stops.</p>						

# DMC 4001

Symbol	Function		
PRIO 1  PRIO 2	Priority display setting switch. "Priority display" is display that returns to the previous display if no operation is performed within 5 seconds after the display was switched. These switches are valid only when the NOCLK switch is set to 0 (clock mode) when the device is not in the DK standby mode and radio monitor is not used. Their settings are shown below.		
	PRIO1	PRIO2	Priority Display
0	0	None	Description  Display switching is performed when the <span style="border: 1px solid black; padding: 2px;">DISP</span> key and melody selection key (during clock display) was operated. - Radio mode The display switches between frequency display and clock display each time the <span style="border: 1px solid black; padding: 2px;">DISP</span> key is pressed. When the melody selection key is pressed during clock display, the display switches to frequency display. - Time mode The <span style="border: 1px solid black; padding: 2px;">DISP</span> key is disabled.  - CD mode The display is switched between " <span style="border: 1px solid black; padding: 2px;">[CD]</span> " display and clock display each time the <span style="border: 1px solid black; padding: 2px;">DISP</span> key is pressed.
1	0	Frequency CD	Description  When the display switched from frequency or " <span style="border: 1px solid black; padding: 2px;">[CD]</span> " display to clock display by <span style="border: 1px solid black; padding: 2px;">DISP</span> key, if no operation is performed within 5 seconds, the display returns to the original display. - Radio mode Normally the frequency is displayed. The display is switched to 5 seconds clock display by pressing the <span style="border: 1px solid black; padding: 2px;">DISP</span> key. When the <span style="border: 1px solid black; padding: 2px;">DISP</span> key is pressed again, or the melody selection key is pressed, during 5 seconds clock display, the display returns to frequency display. - Tape mode Clock display. The <span style="border: 1px solid black; padding: 2px;">DISP</span> key is invalid.  - CD mode Normally " <span style="border: 1px solid black; padding: 2px;">[CD]</span> " is displayed. The display is switched to 5 seconds clock display by pressing the <span style="border: 1px solid black; padding: 2px;">DISP</span> key. When the <span style="border: 1px solid black; padding: 2px;">DISP</span> key is pressed again during 5 seconds clock display, the display returns to CD display.

# DMC 4001

Symbol	Function			Description
PRIO 1  PRIO 2	0	1	Clock	<p>In the radio and CE modes, clock display has priority.</p> <p>- Radio mode</p> <p>Normally the clock is displayed.</p> <p>The display is switched to 5 seconds frequency display by pressing the <span style="border: 1px solid black; padding: 2px;">DISP</span> key or melody selection key.</p> <p>When the <span style="border: 1px solid black; padding: 2px;">DISP</span> key is pressed again during 5 seconds frequency display, the display returns to clock display.</p> <p>- Tape mode</p> <p>The <span style="border: 1px solid black; padding: 2px;">DISP</span> key is invalid.</p> <p>- CD mode</p> <p>Normally the clock is displayed.</p> <p>The display is switched to 5 seconds "<span style="border: 1px solid black; padding: 2px;">f</span>" display by pressing the <span style="border: 1px solid black; padding: 2px;">DISP</span> key.</p> <p>When the <span style="border: 1px solid black; padding: 2px;">DISP</span> key is pressed again during 5 seconds "<span style="border: 1px solid black; padding: 2px;">f</span>" display, the display returns to clock display.</p>
	1	1	—	Do not set to this mode.
	<p>"Frequency display" in the above means receiving frequency, receiving band, and preset memory display. Therefore, during radio reception, the "PSCAN", "SK", "VF", "ST", "MONO", "LOCAL" and "LOUD" displays light even at clock display.</p> <p>In the tape mode, the "LOUD", "MTL", "NR1", "NR2", "AMS" and "▷", "◁" displays also light at clock display.</p>			

Symbol	Function		
	PRIO1	PRIO2	Priority Display
PRIO 1 PRIO 2	0	0	None
	<p>                             - Type DK standby                              - Radio monitor                              The display switches between frequency display and clock display each time the <span style="border: 1px solid black; padding: 0 5px;">DISP</span> key is pressed.                              When the melody selection key is pressed during clock display, the display switches to frequency display.                              When the device entered the tape DK standby and radio monitor standby mode, frequency is displayed first.                         </p> <p>                             - CD DK standby                              - Radio monitor                              The display switches between frequency display, "⌚" display and clock display each time the <span style="border: 1px solid black; padding: 0 5px;">DISP</span> key is pressed.                              When the melody selection key is pressed during "⌚" display and clock display, the display switches to frequency display.                              When the device entered the CD DK standby and radio monitor mode, frequency is displayed first.                         </p> <p>                             - DK ON                              Frequency displayed.                              The <span style="border: 1px solid black; padding: 0 5px;">DISP</span> key is invalid.                         </p>		
	1	0	Frequency CD
<p>                             - Tape DK standby                              - Radio monitor                              Normally the frequency is displayed. The display is switched to 5 seconds clock display by pressing the <span style="border: 1px solid black; padding: 0 5px;">DISP</span> key.                              When the <span style="border: 1px solid black; padding: 0 5px;">DISP</span> key or the melody selection key is pressed during 5 seconds clock display, the display returns to frequency display.                         </p> <p>                             - CD DK standby                              - Radio Monitor                              Normally "⌚" is displayed. When the <span style="border: 1px solid black; padding: 0 5px;">DISP</span> key is pressed, the display switches to 5 seconds frequency display.                              When the <span style="border: 1px solid black; padding: 0 5px;">DISP</span> key is pressed during frequency display, the display switches to 5 seconds clock display.                              When the <span style="border: 1px solid black; padding: 0 5px;">DISP</span> key is pressed during clock display, the display returns to "⌚" display.                              When the melody selection key is pressed during "⌚" and clock display, the display switches to 5 seconds frequency display.                         </p> <p>                             - DK ON                              Frequency display                              The <span style="border: 1px solid black; padding: 0 5px;">DISP</span> key is invalid.                         </p>			

Symbol	Function								
PRIO 1 PRIO 2	PRIO 1	PRIO 2	Priority Display						
	0	1	Clock						
	Description								
			- Tape DK standby - Radio monitor Normally the clock is displayed. When the <span style="border: 1px solid black; padding: 2px;">DISP</span> key or melody selection key is pressed, the display switches to 5 seconds frequency display. When the <span style="border: 1px solid black; padding: 2px;">DISP</span> key is pressed during 5 seconds frequency display the display returns to clock display. - CD DK standby - Radio monitor Normally the clock is displayed. When the <span style="border: 1px solid black; padding: 2px;">DISP</span> key is pressed, the display switches 5 seconds "CD" display. When the <span style="border: 1px solid black; padding: 2px;">DISP</span> key is pressed during this "CD" display, the display switches to 5 seconds frequency display. When the <span style="border: 1px solid black; padding: 2px;">DISP</span> key is pressed during frequency display, the display returns to clock display. When the melody selection key is pressed during clock display or "CD" display, the display switches to 5 seconds frequency display. - DK ON Frequency display. The <span style="border: 1px solid black; padding: 2px;">DISP</span> key is invalid.						
1	1	—	Do not set to this mode.						
At no clock (NOCLK = 1), the following is displayed and the <span style="border: 1px solid black; padding: 2px;">DISP</span> key becomes invalid without regard to the setting of the PRIO1 and PRIO2 switches. And the <span style="border: 1px solid black; padding: 2px;">DISP</span> key is invalid.									
Mode		Display							
Radio		Frequency							
Tape		None							
CD		CD							
Tape DK standby CD DK standby DK ON Radio monitor		Frequency							
RDON	Radio ON/OFF method setting switch. Its setting is shown below.								
	<table border="1" style="margin: auto; border-collapse: collapse;"> <thead> <tr> <th style="width: 15%;">RDON</th> <th>Radio ON/OFF Method</th> </tr> </thead> <tbody> <tr> <td style="text-align: center;">0</td> <td>Radio is turned on and off by RSET switch</td> </tr> <tr> <td style="text-align: center;">1</td> <td>Radio is turned on by making the CE pin High.</td> </tr> </tbody> </table>			RDON	Radio ON/OFF Method	0	Radio is turned on and off by RSET switch	1	Radio is turned on by making the CE pin High.
RDON	Radio ON/OFF Method								
0	Radio is turned on and off by RSET switch								
1	Radio is turned on by making the CE pin High.								
	When this switch was set to 1, do not use the RSET switch.								

Symbol	Function						
NOCLK	<p>Clock specified setting switch. Its setting is shown below.</p> <table border="1" style="margin-left: auto; margin-right: auto;"> <thead> <tr> <th>NOCLK</th> <th>Clock</th> </tr> </thead> <tbody> <tr> <td style="text-align: center;">0</td> <td style="text-align: center;">Yes</td> </tr> <tr> <td style="text-align: center;">1</td> <td style="text-align: center;">No</td> </tr> </tbody> </table> <p>In the no clock mode, low consumption current ( 10 <math>\mu</math>A max) backup is possible by making the CE pin Low.</p>	NOCLK	Clock	0	Yes	1	No
NOCLK	Clock						
0	Yes						
1	No						
CLKDISP	<p>Clock time system setting switch. Its setting is shown below.</p> <table border="1" style="margin-left: auto; margin-right: auto;"> <thead> <tr> <th>CLKDISP</th> <th>Time System</th> </tr> </thead> <tbody> <tr> <td style="text-align: center;">0</td> <td> <p style="text-align: center;">12-hour clock</p> <div style="text-align: center;"> <span style="font-size: 2em;">}</span> AM 11:59 → PM 12:00  <span style="font-size: 2em;">}</span> AM 12:00 ← PM 11:59                 </div> </td> </tr> <tr> <td style="text-align: center;">1</td> <td> <p style="text-align: center;">24-hour clock</p> <div style="text-align: center;"> <span style="font-size: 2em;">}</span> 23:59 → 0:00                 </div> </td> </tr> </tbody> </table>	CLKDISP	Time System	0	<p style="text-align: center;">12-hour clock</p> <div style="text-align: center;"> <span style="font-size: 2em;">}</span> AM 11:59 → PM 12:00  <span style="font-size: 2em;">}</span> AM 12:00 ← PM 11:59                 </div>	1	<p style="text-align: center;">24-hour clock</p> <div style="text-align: center;"> <span style="font-size: 2em;">}</span> 23:59 → 0:00                 </div>
CLKDISP	Time System						
0	<p style="text-align: center;">12-hour clock</p> <div style="text-align: center;"> <span style="font-size: 2em;">}</span> AM 11:59 → PM 12:00  <span style="font-size: 2em;">}</span> AM 12:00 ← PM 11:59                 </div>						
1	<p style="text-align: center;">24-hour clock</p> <div style="text-align: center;"> <span style="font-size: 2em;">}</span> 23:59 → 0:00                 </div>						
FLASH	<p>Clock colon ( : ) display setting switch. Its setting is shown below.</p> <table border="1" style="margin-left: auto; margin-right: auto;"> <thead> <tr> <th>FLASH</th> <th>Colon ( : ) Display</th> </tr> </thead> <tbody> <tr> <td style="text-align: center;">0</td> <td style="text-align: center;">Steady light</td> </tr> <tr> <td style="text-align: center;">1</td> <td> <p style="text-align: center;">Flashing</p> <p style="text-align: center;">Frequency : 1Hz</p> <p style="text-align: center;">Duty → 6 (ON) : 4 (OFF)</p> </td> </tr> </tbody> </table>	FLASH	Colon ( : ) Display	0	Steady light	1	<p style="text-align: center;">Flashing</p> <p style="text-align: center;">Frequency : 1Hz</p> <p style="text-align: center;">Duty → 6 (ON) : 4 (OFF)</p>
FLASH	Colon ( : ) Display						
0	Steady light						
1	<p style="text-align: center;">Flashing</p> <p style="text-align: center;">Frequency : 1Hz</p> <p style="text-align: center;">Duty → 6 (ON) : 4 (OFF)</p>						

Symbol	Function																																																																																																																						
	<p>Switches for using the tape functions (AMS, NR, MTL) in common with the radio function keys. The keys that can be used in common can be selected as shown below.</p> <table border="1" style="width: 100%; border-collapse: collapse;"> <thead> <tr> <th style="width: 10%;">ENTPK</th> <th colspan="5">Description</th> </tr> </thead> <tbody> <tr> <td style="text-align: center; vertical-align: middle;">0</td> <td colspan="5"> <p>The <span style="border: 1px solid black; padding: 2px;">M1 (TP1)</span>, <span style="border: 1px solid black; padding: 2px;">M2 (TP2)</span> and <span style="border: 1px solid black; padding: 2px;">M3 (TP3)</span> keys can be used as the AMS, NR, MTL function keys.</p> <p>The keys that can be selected as shown below.</p> <table border="1" style="width: 100%; border-collapse: collapse;"> <thead> <tr> <th rowspan="2" style="width: 10%;">KAMS</th> <th rowspan="2" style="width: 10%;">KNR</th> <th rowspan="2" style="width: 10%;">KMTL</th> <th colspan="3">Dual Function Key</th> </tr> <tr> <th style="border: 1px solid black; padding: 2px;">M1 (TP1)</th> <th style="border: 1px solid black; padding: 2px;">M2 (TP2)</th> <th style="border: 1px solid black; padding: 2px;">M3 (TP3)</th> </tr> </thead> <tbody> <tr><td style="text-align: center;">1</td><td style="text-align: center;">1</td><td style="text-align: center;">1</td><td style="text-align: center;">AMS</td><td style="text-align: center;">NR</td><td style="text-align: center;">MTL</td></tr> <tr><td style="text-align: center;">1</td><td style="text-align: center;">1</td><td style="text-align: center;">0</td><td style="text-align: center;">AMS</td><td style="text-align: center;">NR</td><td style="text-align: center;">—</td></tr> <tr><td style="text-align: center;">1</td><td style="text-align: center;">0</td><td style="text-align: center;">1</td><td style="text-align: center;">AMS</td><td style="text-align: center;">MTL</td><td style="text-align: center;">—</td></tr> <tr><td style="text-align: center;">1</td><td style="text-align: center;">0</td><td style="text-align: center;">0</td><td style="text-align: center;">AMS</td><td style="text-align: center;">—</td><td style="text-align: center;">—</td></tr> <tr><td style="text-align: center;">0</td><td style="text-align: center;">1</td><td style="text-align: center;">1</td><td style="text-align: center;">NR</td><td style="text-align: center;">MTL</td><td style="text-align: center;">—</td></tr> <tr><td style="text-align: center;">0</td><td style="text-align: center;">1</td><td style="text-align: center;">0</td><td style="text-align: center;">NR</td><td style="text-align: center;">—</td><td style="text-align: center;">—</td></tr> <tr><td style="text-align: center;">0</td><td style="text-align: center;">0</td><td style="text-align: center;">1</td><td style="text-align: center;">MTL</td><td style="text-align: center;">—</td><td style="text-align: center;">—</td></tr> <tr><td style="text-align: center;">0</td><td style="text-align: center;">0</td><td style="text-align: center;">0</td><td style="text-align: center;">—</td><td style="text-align: center;">—</td><td style="text-align: center;">—</td></tr> </tbody> </table> <p>That is, the functions selected by 1 are left-justified and used at the <span style="border: 1px solid black; padding: 2px;">M1 (TP1)</span> to <span style="border: 1px solid black; padding: 2px;">M3 (TP3)</span> keys.</p> </td> </tr> <tr> <td style="text-align: center; vertical-align: middle;">1</td> <td> <p>Of the AMS, NR and MTL function keys, two functions can be used at the <span style="border: 1px solid black; padding: 2px;">LOC (TP4)</span> and <span style="border: 1px solid black; padding: 2px;">MONO (TP5)</span> keys.</p> <p>The following can be selected :</p> <table border="1" style="width: 100%; border-collapse: collapse;"> <thead> <tr> <th rowspan="2" style="width: 10%;">KAMS</th> <th rowspan="2" style="width: 10%;">KNR</th> <th rowspan="2" style="width: 10%;">KMTL</th> <th colspan="2">Dual Function Key</th> </tr> <tr> <th style="border: 1px solid black; padding: 2px;">LOC (TP4)</th> <th style="border: 1px solid black; padding: 2px;">MONO (TP5)</th> </tr> </thead> <tbody> <tr> <td style="text-align: center;">1</td> <td style="text-align: center;">1</td> <td style="text-align: center;">1</td> <td colspan="2" style="text-align: center;">Do not set</td> </tr> <tr> <td style="text-align: center;">1</td> <td style="text-align: center;">1</td> <td style="text-align: center;">0</td> <td style="text-align: center;">AMS</td> <td style="text-align: center;">NR</td> </tr> <tr> <td style="text-align: center;">1</td> <td style="text-align: center;">0</td> <td style="text-align: center;">1</td> <td style="text-align: center;">AMS</td> <td style="text-align: center;">MTL</td> </tr> <tr> <td style="text-align: center;">1</td> <td style="text-align: center;">0</td> <td style="text-align: center;">0</td> <td style="text-align: center;">AMS</td> <td style="text-align: center;">—</td> </tr> <tr> <td style="text-align: center;">0</td> <td style="text-align: center;">1</td> <td style="text-align: center;">1</td> <td style="text-align: center;">NR</td> <td style="text-align: center;">MTL</td> </tr> <tr> <td style="text-align: center;">0</td> <td style="text-align: center;">1</td> <td style="text-align: center;">0</td> <td style="text-align: center;">NR</td> <td style="text-align: center;">—</td> </tr> <tr> <td style="text-align: center;">0</td> <td style="text-align: center;">0</td> <td style="text-align: center;">1</td> <td style="text-align: center;">MTL</td> <td style="text-align: center;">—</td> </tr> <tr> <td style="text-align: center;">0</td> <td style="text-align: center;">0</td> <td style="text-align: center;">0</td> <td style="text-align: center;">—</td> <td style="text-align: center;">—</td> </tr> </tbody> </table> <p>The functions selected by 1 are left-justified and used at the <span style="border: 1px solid black; padding: 2px;">LOC (TP4)</span> and <span style="border: 1px solid black; padding: 2px;">MONO (TP5)</span> keys.</p> </td> </tr> </tbody> </table>	ENTPK	Description					0	<p>The <span style="border: 1px solid black; padding: 2px;">M1 (TP1)</span>, <span style="border: 1px solid black; padding: 2px;">M2 (TP2)</span> and <span style="border: 1px solid black; padding: 2px;">M3 (TP3)</span> keys can be used as the AMS, NR, MTL function keys.</p> <p>The keys that can be selected as shown below.</p> <table border="1" style="width: 100%; border-collapse: collapse;"> <thead> <tr> <th rowspan="2" style="width: 10%;">KAMS</th> <th rowspan="2" style="width: 10%;">KNR</th> <th rowspan="2" style="width: 10%;">KMTL</th> <th colspan="3">Dual Function Key</th> </tr> <tr> <th style="border: 1px solid black; padding: 2px;">M1 (TP1)</th> <th style="border: 1px solid black; padding: 2px;">M2 (TP2)</th> <th style="border: 1px solid black; padding: 2px;">M3 (TP3)</th> </tr> </thead> <tbody> <tr><td style="text-align: center;">1</td><td style="text-align: center;">1</td><td style="text-align: center;">1</td><td style="text-align: center;">AMS</td><td style="text-align: center;">NR</td><td style="text-align: center;">MTL</td></tr> <tr><td style="text-align: center;">1</td><td style="text-align: center;">1</td><td style="text-align: center;">0</td><td style="text-align: center;">AMS</td><td style="text-align: center;">NR</td><td style="text-align: center;">—</td></tr> <tr><td style="text-align: center;">1</td><td style="text-align: center;">0</td><td style="text-align: center;">1</td><td style="text-align: center;">AMS</td><td style="text-align: center;">MTL</td><td style="text-align: center;">—</td></tr> <tr><td style="text-align: center;">1</td><td style="text-align: center;">0</td><td style="text-align: center;">0</td><td style="text-align: center;">AMS</td><td style="text-align: center;">—</td><td style="text-align: center;">—</td></tr> <tr><td style="text-align: center;">0</td><td style="text-align: center;">1</td><td style="text-align: center;">1</td><td style="text-align: center;">NR</td><td style="text-align: center;">MTL</td><td style="text-align: center;">—</td></tr> <tr><td style="text-align: center;">0</td><td style="text-align: center;">1</td><td style="text-align: center;">0</td><td style="text-align: center;">NR</td><td style="text-align: center;">—</td><td style="text-align: center;">—</td></tr> <tr><td style="text-align: center;">0</td><td style="text-align: center;">0</td><td style="text-align: center;">1</td><td style="text-align: center;">MTL</td><td style="text-align: center;">—</td><td style="text-align: center;">—</td></tr> <tr><td style="text-align: center;">0</td><td style="text-align: center;">0</td><td style="text-align: center;">0</td><td style="text-align: center;">—</td><td style="text-align: center;">—</td><td style="text-align: center;">—</td></tr> </tbody> </table> <p>That is, the functions selected by 1 are left-justified and used at the <span style="border: 1px solid black; padding: 2px;">M1 (TP1)</span> to <span style="border: 1px solid black; padding: 2px;">M3 (TP3)</span> keys.</p>					KAMS	KNR	KMTL	Dual Function Key			M1 (TP1)	M2 (TP2)	M3 (TP3)	1	1	1	AMS	NR	MTL	1	1	0	AMS	NR	—	1	0	1	AMS	MTL	—	1	0	0	AMS	—	—	0	1	1	NR	MTL	—	0	1	0	NR	—	—	0	0	1	MTL	—	—	0	0	0	—	—	—	1	<p>Of the AMS, NR and MTL function keys, two functions can be used at the <span style="border: 1px solid black; padding: 2px;">LOC (TP4)</span> and <span style="border: 1px solid black; padding: 2px;">MONO (TP5)</span> keys.</p> <p>The following can be selected :</p> <table border="1" style="width: 100%; border-collapse: collapse;"> <thead> <tr> <th rowspan="2" style="width: 10%;">KAMS</th> <th rowspan="2" style="width: 10%;">KNR</th> <th rowspan="2" style="width: 10%;">KMTL</th> <th colspan="2">Dual Function Key</th> </tr> <tr> <th style="border: 1px solid black; padding: 2px;">LOC (TP4)</th> <th style="border: 1px solid black; padding: 2px;">MONO (TP5)</th> </tr> </thead> <tbody> <tr> <td style="text-align: center;">1</td> <td style="text-align: center;">1</td> <td style="text-align: center;">1</td> <td colspan="2" style="text-align: center;">Do not set</td> </tr> <tr> <td style="text-align: center;">1</td> <td style="text-align: center;">1</td> <td style="text-align: center;">0</td> <td style="text-align: center;">AMS</td> <td style="text-align: center;">NR</td> </tr> <tr> <td style="text-align: center;">1</td> <td style="text-align: center;">0</td> <td style="text-align: center;">1</td> <td style="text-align: center;">AMS</td> <td style="text-align: center;">MTL</td> </tr> <tr> <td style="text-align: center;">1</td> <td style="text-align: center;">0</td> <td style="text-align: center;">0</td> <td style="text-align: center;">AMS</td> <td style="text-align: center;">—</td> </tr> <tr> <td style="text-align: center;">0</td> <td style="text-align: center;">1</td> <td style="text-align: center;">1</td> <td style="text-align: center;">NR</td> <td style="text-align: center;">MTL</td> </tr> <tr> <td style="text-align: center;">0</td> <td style="text-align: center;">1</td> <td style="text-align: center;">0</td> <td style="text-align: center;">NR</td> <td style="text-align: center;">—</td> </tr> <tr> <td style="text-align: center;">0</td> <td style="text-align: center;">0</td> <td style="text-align: center;">1</td> <td style="text-align: center;">MTL</td> <td style="text-align: center;">—</td> </tr> <tr> <td style="text-align: center;">0</td> <td style="text-align: center;">0</td> <td style="text-align: center;">0</td> <td style="text-align: center;">—</td> <td style="text-align: center;">—</td> </tr> </tbody> </table> <p>The functions selected by 1 are left-justified and used at the <span style="border: 1px solid black; padding: 2px;">LOC (TP4)</span> and <span style="border: 1px solid black; padding: 2px;">MONO (TP5)</span> keys.</p>	KAMS	KNR	KMTL	Dual Function Key		LOC (TP4)	MONO (TP5)	1	1	1	Do not set		1	1	0	AMS	NR	1	0	1	AMS	MTL	1	0	0	AMS	—	0	1	1	NR	MTL	0	1	0	NR	—	0	0	1	MTL	—	0	0	0	—	—
ENTPK	Description																																																																																																																						
0	<p>The <span style="border: 1px solid black; padding: 2px;">M1 (TP1)</span>, <span style="border: 1px solid black; padding: 2px;">M2 (TP2)</span> and <span style="border: 1px solid black; padding: 2px;">M3 (TP3)</span> keys can be used as the AMS, NR, MTL function keys.</p> <p>The keys that can be selected as shown below.</p> <table border="1" style="width: 100%; border-collapse: collapse;"> <thead> <tr> <th rowspan="2" style="width: 10%;">KAMS</th> <th rowspan="2" style="width: 10%;">KNR</th> <th rowspan="2" style="width: 10%;">KMTL</th> <th colspan="3">Dual Function Key</th> </tr> <tr> <th style="border: 1px solid black; padding: 2px;">M1 (TP1)</th> <th style="border: 1px solid black; padding: 2px;">M2 (TP2)</th> <th style="border: 1px solid black; padding: 2px;">M3 (TP3)</th> </tr> </thead> <tbody> <tr><td style="text-align: center;">1</td><td style="text-align: center;">1</td><td style="text-align: center;">1</td><td style="text-align: center;">AMS</td><td style="text-align: center;">NR</td><td style="text-align: center;">MTL</td></tr> <tr><td style="text-align: center;">1</td><td style="text-align: center;">1</td><td style="text-align: center;">0</td><td style="text-align: center;">AMS</td><td style="text-align: center;">NR</td><td style="text-align: center;">—</td></tr> <tr><td style="text-align: center;">1</td><td style="text-align: center;">0</td><td style="text-align: center;">1</td><td style="text-align: center;">AMS</td><td style="text-align: center;">MTL</td><td style="text-align: center;">—</td></tr> <tr><td style="text-align: center;">1</td><td style="text-align: center;">0</td><td style="text-align: center;">0</td><td style="text-align: center;">AMS</td><td style="text-align: center;">—</td><td style="text-align: center;">—</td></tr> <tr><td style="text-align: center;">0</td><td style="text-align: center;">1</td><td style="text-align: center;">1</td><td style="text-align: center;">NR</td><td style="text-align: center;">MTL</td><td style="text-align: center;">—</td></tr> <tr><td style="text-align: center;">0</td><td style="text-align: center;">1</td><td style="text-align: center;">0</td><td style="text-align: center;">NR</td><td style="text-align: center;">—</td><td style="text-align: center;">—</td></tr> <tr><td style="text-align: center;">0</td><td style="text-align: center;">0</td><td style="text-align: center;">1</td><td style="text-align: center;">MTL</td><td style="text-align: center;">—</td><td style="text-align: center;">—</td></tr> <tr><td style="text-align: center;">0</td><td style="text-align: center;">0</td><td style="text-align: center;">0</td><td style="text-align: center;">—</td><td style="text-align: center;">—</td><td style="text-align: center;">—</td></tr> </tbody> </table> <p>That is, the functions selected by 1 are left-justified and used at the <span style="border: 1px solid black; padding: 2px;">M1 (TP1)</span> to <span style="border: 1px solid black; padding: 2px;">M3 (TP3)</span> keys.</p>					KAMS	KNR	KMTL	Dual Function Key			M1 (TP1)	M2 (TP2)	M3 (TP3)	1	1	1	AMS	NR	MTL	1	1	0	AMS	NR	—	1	0	1	AMS	MTL	—	1	0	0	AMS	—	—	0	1	1	NR	MTL	—	0	1	0	NR	—	—	0	0	1	MTL	—	—	0	0	0	—	—	—																																																									
KAMS	KNR	KMTL	Dual Function Key																																																																																																																				
			M1 (TP1)	M2 (TP2)	M3 (TP3)																																																																																																																		
1	1	1	AMS	NR	MTL																																																																																																																		
1	1	0	AMS	NR	—																																																																																																																		
1	0	1	AMS	MTL	—																																																																																																																		
1	0	0	AMS	—	—																																																																																																																		
0	1	1	NR	MTL	—																																																																																																																		
0	1	0	NR	—	—																																																																																																																		
0	0	1	MTL	—	—																																																																																																																		
0	0	0	—	—	—																																																																																																																		
1	<p>Of the AMS, NR and MTL function keys, two functions can be used at the <span style="border: 1px solid black; padding: 2px;">LOC (TP4)</span> and <span style="border: 1px solid black; padding: 2px;">MONO (TP5)</span> keys.</p> <p>The following can be selected :</p> <table border="1" style="width: 100%; border-collapse: collapse;"> <thead> <tr> <th rowspan="2" style="width: 10%;">KAMS</th> <th rowspan="2" style="width: 10%;">KNR</th> <th rowspan="2" style="width: 10%;">KMTL</th> <th colspan="2">Dual Function Key</th> </tr> <tr> <th style="border: 1px solid black; padding: 2px;">LOC (TP4)</th> <th style="border: 1px solid black; padding: 2px;">MONO (TP5)</th> </tr> </thead> <tbody> <tr> <td style="text-align: center;">1</td> <td style="text-align: center;">1</td> <td style="text-align: center;">1</td> <td colspan="2" style="text-align: center;">Do not set</td> </tr> <tr> <td style="text-align: center;">1</td> <td style="text-align: center;">1</td> <td style="text-align: center;">0</td> <td style="text-align: center;">AMS</td> <td style="text-align: center;">NR</td> </tr> <tr> <td style="text-align: center;">1</td> <td style="text-align: center;">0</td> <td style="text-align: center;">1</td> <td style="text-align: center;">AMS</td> <td style="text-align: center;">MTL</td> </tr> <tr> <td style="text-align: center;">1</td> <td style="text-align: center;">0</td> <td style="text-align: center;">0</td> <td style="text-align: center;">AMS</td> <td style="text-align: center;">—</td> </tr> <tr> <td style="text-align: center;">0</td> <td style="text-align: center;">1</td> <td style="text-align: center;">1</td> <td style="text-align: center;">NR</td> <td style="text-align: center;">MTL</td> </tr> <tr> <td style="text-align: center;">0</td> <td style="text-align: center;">1</td> <td style="text-align: center;">0</td> <td style="text-align: center;">NR</td> <td style="text-align: center;">—</td> </tr> <tr> <td style="text-align: center;">0</td> <td style="text-align: center;">0</td> <td style="text-align: center;">1</td> <td style="text-align: center;">MTL</td> <td style="text-align: center;">—</td> </tr> <tr> <td style="text-align: center;">0</td> <td style="text-align: center;">0</td> <td style="text-align: center;">0</td> <td style="text-align: center;">—</td> <td style="text-align: center;">—</td> </tr> </tbody> </table> <p>The functions selected by 1 are left-justified and used at the <span style="border: 1px solid black; padding: 2px;">LOC (TP4)</span> and <span style="border: 1px solid black; padding: 2px;">MONO (TP5)</span> keys.</p>	KAMS	KNR	KMTL	Dual Function Key		LOC (TP4)	MONO (TP5)	1	1	1	Do not set		1	1	0	AMS	NR	1	0	1	AMS	MTL	1	0	0	AMS	—	0	1	1	NR	MTL	0	1	0	NR	—	0	0	1	MTL	—	0	0	0	—	—																																																																							
KAMS	KNR				KMTL	Dual Function Key																																																																																																																	
		LOC (TP4)	MONO (TP5)																																																																																																																				
1	1	1	Do not set																																																																																																																				
1	1	0	AMS	NR																																																																																																																			
1	0	1	AMS	MTL																																																																																																																			
1	0	0	AMS	—																																																																																																																			
0	1	1	NR	MTL																																																																																																																			
0	1	0	NR	—																																																																																																																			
0	0	1	MTL	—																																																																																																																			
0	0	0	—	—																																																																																																																			

ENTPK  
KAMS  
KNR  
KMTL

# DMC 4001

Symbol	Function								
	The operation of each key is the same as that of the momentary keys <span style="border: 1px solid black; padding: 2px;">AMS</span> , <span style="border: 1px solid black; padding: 2px;">NR</span> , and <span style="border: 1px solid black; padding: 2px;">MTL</span> . Summarizing the above, the five keys <span style="border: 1px solid black; padding: 2px;">M1 (TP1)</span> to <span style="border: 1px solid black; padding: 2px;">M3 (TP3)</span> , <span style="border: 1px solid black; padding: 2px;">LOC (TP4)</span> and scan be used as <span style="border: 1px solid black; padding: 2px;">MONO (TP5)</span> tape function keys. Which functions used in common are determined by the ENTPK, KAMS, KNR and KMTL switches. This summarized below.								
	ENTPK	KAMS	KNR	KMTL	M1 (TP1)	M2 (TP2)	M3 (TP3)	LOC (TP4)	MONO (TP5)
	0	1 1 1 1 0 0 0	1 1 0 0 1 1 0	1 0 1 0 1 0 0	AMS AMS AMS AMS NR NR MTL	NR NR MTL MTL	MTL		
ENTPK KAMS KNR KMTL	1	1 1 1 0 0 0	1 1 0 1 1 0 0	1 0 1 0 1 0 0	Do not set.			AMS AMS AMS NR NR MTL	NR MTL MTL
	When these functions are used, tuning operations in the tape DK standby, CD DK standby and radio monitor and DK ON modes are restricted as follows :								
	ENTPK	KAMS	KNR	KMTL					
	0	0	0	0	Normal tuning possible.				
	0	When even switch is 1			Tuning by <span style="border: 1px solid black; padding: 2px;">M1 (TP1)</span> to <span style="border: 1px solid black; padding: 2px;">M6</span> key is possible.				
	1	—	—	—	The <span style="border: 1px solid black; padding: 2px;">LOC (TP4)</span> and <span style="border: 1px solid black; padding: 2px;">MONO (TP5)</span> keys cannot be used as local and monaural keys.				



# DMC 4001

Symbol	Function						
ENNR2	<p>Switch that enables the NR2 (Noise Reduction) function in the tape mode. Its setting is shown below.</p> <table border="1" style="width: 100%; border-collapse: collapse;"> <thead> <tr> <th style="width: 15%;">ENNR2</th> <th>Description</th> </tr> </thead> <tbody> <tr> <td style="text-align: center; vertical-align: middle;">0</td> <td> <p>NR2 function cannot be used. When the <span style="border: 1px solid black; padding: 2px;">NR</span> key or NR function key (selected by KNR switch) is pressed, the LCD panel "NR1" display and NR1 pin output changes as follows :</p> <div style="text-align: center;"> </div> </td> </tr> <tr> <td style="text-align: center; vertical-align: middle;">1</td> <td> <p>Both the NR1 and NR2 functions can be used. When the <span style="border: 1px solid black; padding: 2px;">NR</span> key or NR function key (selected by KNR switch) is pressed, the LCD panel "NR1" and "NR2" displays and NR1 and MONO/NR2 pins output change as follows :</p> <div style="text-align: center;"> </div> </td> </tr> </tbody> </table>	ENNR2	Description	0	<p>NR2 function cannot be used. When the <span style="border: 1px solid black; padding: 2px;">NR</span> key or NR function key (selected by KNR switch) is pressed, the LCD panel "NR1" display and NR1 pin output changes as follows :</p> <div style="text-align: center;"> </div>	1	<p>Both the NR1 and NR2 functions can be used. When the <span style="border: 1px solid black; padding: 2px;">NR</span> key or NR function key (selected by KNR switch) is pressed, the LCD panel "NR1" and "NR2" displays and NR1 and MONO/NR2 pins output change as follows :</p> <div style="text-align: center;"> </div>
	ENNR2	Description					
0	<p>NR2 function cannot be used. When the <span style="border: 1px solid black; padding: 2px;">NR</span> key or NR function key (selected by KNR switch) is pressed, the LCD panel "NR1" display and NR1 pin output changes as follows :</p> <div style="text-align: center;"> </div>						
1	<p>Both the NR1 and NR2 functions can be used. When the <span style="border: 1px solid black; padding: 2px;">NR</span> key or NR function key (selected by KNR switch) is pressed, the LCD panel "NR1" and "NR2" displays and NR1 and MONO/NR2 pins output change as follows :</p> <div style="text-align: center;"> </div>						
MUTESEL	<p>Sets the <b>RDMUTE</b> pin output method in the tape and CD modes. Its setting is shown below.</p> <table border="1" style="width: 100%; border-collapse: collapse;"> <thead> <tr> <th style="width: 15%;">MUTESEL</th> <th>RDMUTE Pin Output</th> </tr> </thead> <tbody> <tr> <td style="text-align: center; vertical-align: middle;">1</td> <td> <p>In the tape and CD modes, muting is turned off.</p> <div style="text-align: center;"> </div> <p>When MUTESEL = 1 is set, do not use the DK standby and radio monitor functions.</p> </td> </tr> <tr> <td style="text-align: center; vertical-align: middle;">0</td> <td> <p>In the tape and CD modes, muting remains ON.</p> <div style="text-align: center;"> </div> <p>When MUTESEL = 0 is set, do not use the DK standby and monitor functions.</p> </td> </tr> </tbody> </table>	MUTESEL	RDMUTE Pin Output	1	<p>In the tape and CD modes, muting is turned off.</p> <div style="text-align: center;"> </div> <p>When MUTESEL = 1 is set, do not use the DK standby and radio monitor functions.</p>	0	<p>In the tape and CD modes, muting remains ON.</p> <div style="text-align: center;"> </div> <p>When MUTESEL = 0 is set, do not use the DK standby and monitor functions.</p>
	MUTESEL	RDMUTE Pin Output					
1	<p>In the tape and CD modes, muting is turned off.</p> <div style="text-align: center;"> </div> <p>When MUTESEL = 1 is set, do not use the DK standby and radio monitor functions.</p>						
0	<p>In the tape and CD modes, muting remains ON.</p> <div style="text-align: center;"> </div> <p>When MUTESEL = 0 is set, do not use the DK standby and monitor functions.</p>						
<p>For details, see "Radio Mute Output Timing"</p>							

# DMC 4001

Symbol	Function																												
ENFMIF DISAMIF	IF counter use setting switch. Its setting is shown below.																												
	<table border="1" style="width: 100%; border-collapse: collapse;"> <thead> <tr> <th style="width: 15%;">ENFMIF</th> <th style="width: 15%;">DISAMIF</th> <th style="width: 15%;">BAND</th> <th style="width: 55%;">Broadcast Station Detection Method</th> </tr> </thead> <tbody> <tr> <td rowspan="2" style="text-align: center;">1</td> <td rowspan="2" style="text-align: center;">0</td> <td style="text-align: center;">FM</td> <td>IF counter and SD system</td> </tr> <tr> <td style="text-align: center;">MW, LW</td> <td>IF counter and SD system</td> </tr> <tr> <td rowspan="2" style="text-align: center;">1</td> <td rowspan="2" style="text-align: center;">1</td> <td style="text-align: center;">FM</td> <td>IF counter and SD system</td> </tr> <tr> <td style="text-align: center;">MW, LW</td> <td>SD system</td> </tr> <tr> <td rowspan="2" style="text-align: center;">0</td> <td rowspan="2" style="text-align: center;">0</td> <td style="text-align: center;">FM</td> <td>SD system</td> </tr> <tr> <td style="text-align: center;">MW, LW</td> <td>IF counter and SD system</td> </tr> <tr> <td rowspan="2" style="text-align: center;">0</td> <td rowspan="2" style="text-align: center;">1</td> <td style="text-align: center;">FM</td> <td>SD system</td> </tr> <tr> <td style="text-align: center;">MW, LW</td> <td>SD system</td> </tr> </tbody> </table>	ENFMIF	DISAMIF	BAND	Broadcast Station Detection Method	1	0	FM	IF counter and SD system	MW, LW	IF counter and SD system	1	1	FM	IF counter and SD system	MW, LW	SD system	0	0	FM	SD system	MW, LW	IF counter and SD system	0	1	FM	SD system	MW, LW	SD system
	ENFMIF	DISAMIF	BAND	Broadcast Station Detection Method																									
	1	0	FM	IF counter and SD system																									
			MW, LW	IF counter and SD system																									
	1	1	FM	IF counter and SD system																									
			MW, LW	SD system																									
	0	0	FM	SD system																									
			MW, LW	IF counter and SD system																									
	0	1	FM	SD system																									
MW, LW			SD system																										
0	0	FM	SD system																										
		MW, LW	IF counter and SD system																										
0	1	FM	SD system																										
		MW, LW	SD system																										

DISAMEMO	Auto preset memory function disable switch. Its setting is shown below.						
	<table border="1" style="width: 100%; border-collapse: collapse;"> <thead> <tr> <th style="width: 20%;">DISAMEMO</th> <th style="width: 80%;">Description</th> </tr> </thead> <tbody> <tr> <td style="text-align: center;">0</td> <td>Enables the auto preset memory function. When the <span style="border: 1px solid black; padding: 2px;">PSCAN MEMO</span> key is pressed for more than 2 seconds, auto preset memory operation begins.</td> </tr> <tr> <td style="text-align: center;">1</td> <td>Disables the auto preset memory function The <span style="border: 1px solid black; padding: 2px;">PSCAN MEMO</span> key performs the preset scan function only.</td> </tr> </tbody> </table>	DISAMEMO	Description	0	Enables the auto preset memory function. When the <span style="border: 1px solid black; padding: 2px;">PSCAN MEMO</span> key is pressed for more than 2 seconds, auto preset memory operation begins.	1	Disables the auto preset memory function The <span style="border: 1px solid black; padding: 2px;">PSCAN MEMO</span> key performs the preset scan function only.
	DISAMEMO	Description					
0	Enables the auto preset memory function. When the <span style="border: 1px solid black; padding: 2px;">PSCAN MEMO</span> key is pressed for more than 2 seconds, auto preset memory operation begins.						
1	Disables the auto preset memory function The <span style="border: 1px solid black; padding: 2px;">PSCAN MEMO</span> key performs the preset scan function only.						

## 3. MODE TRANSITION

With the DMC 4001, the radio can be turned on and off by the following two methods:

- (1) By CE pin when the initialized diode switch RDON = 1
- (2) By turning the transistor or alternate switch RDSET on and off

The mode transition at each operation is described in 3.1, 3.2 and 3.3.

### 3.1 WHEN THE INITIALIZED DIODE RDON = 1 (RADIO ON/OFF BY CE PIN)

The radio mode is turned on and off by CE pin.

Switching to the tape and CD modes is performed by TPSET and CDSET switches, respectively.

When RDON = 1, do not use the RDSET switch.

When the CE pin is made Low level, clock display is not performed.

- (1) CE : Low to High

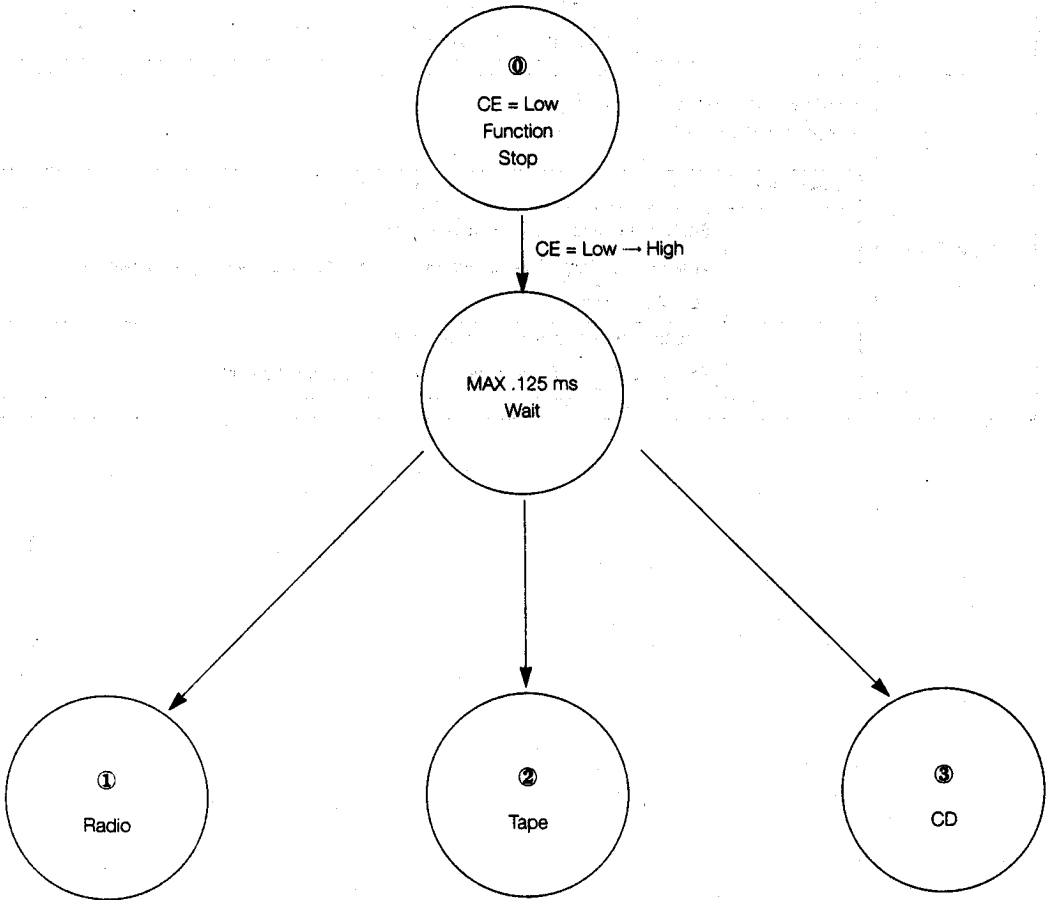

(2) CE : High Level

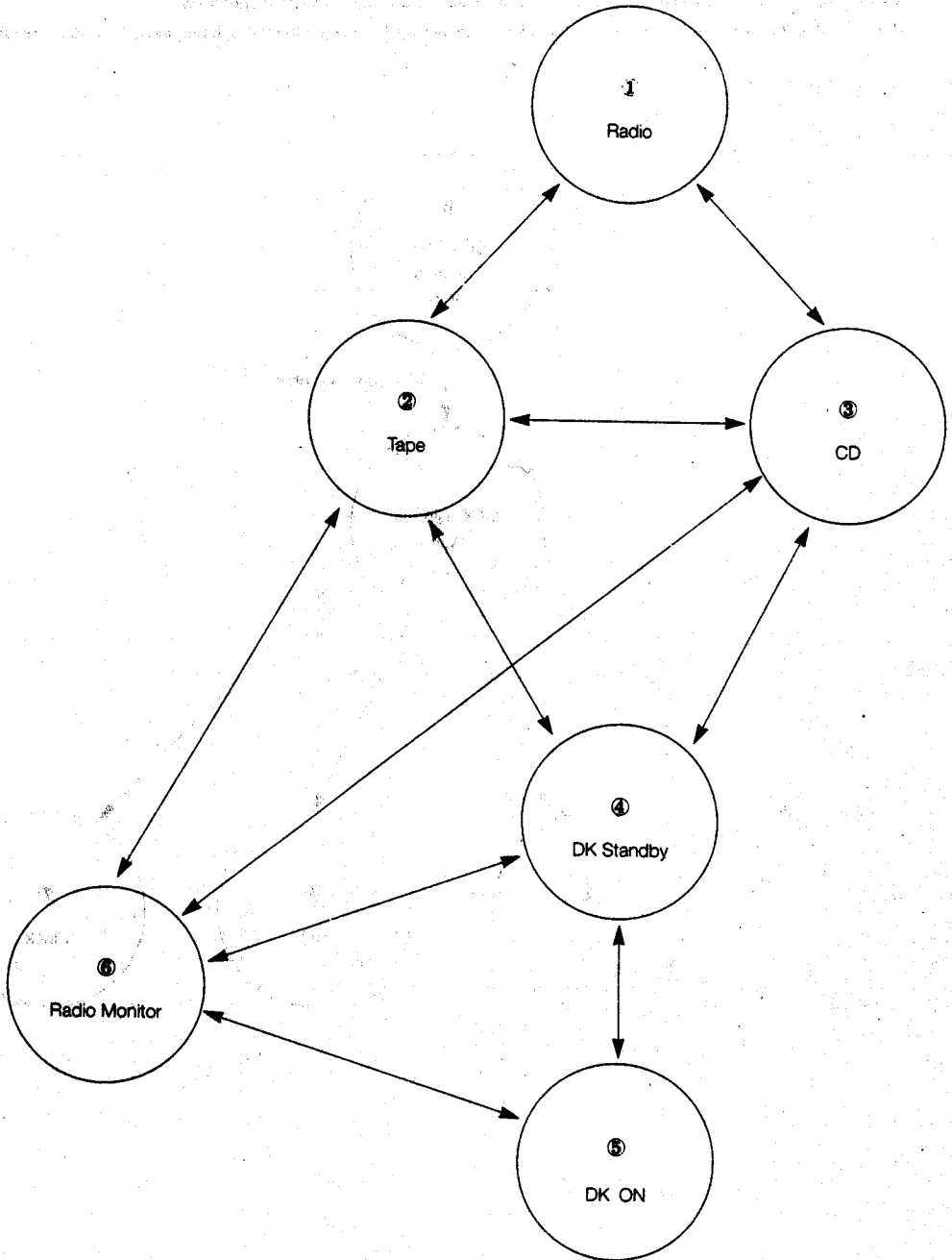

## 3.2 RADIO ON/OFF BY RSET SWITCH

The radio mode is turned on and off by RSET switch.

Switching to the tape and CD mode is performed by TPSET and CDESET switch, respectively.

The difference from RDON=1 of 3.1 is that the clock is displayed even when the radio, tape and CD modes are OFF.

(1) CE : Low to high

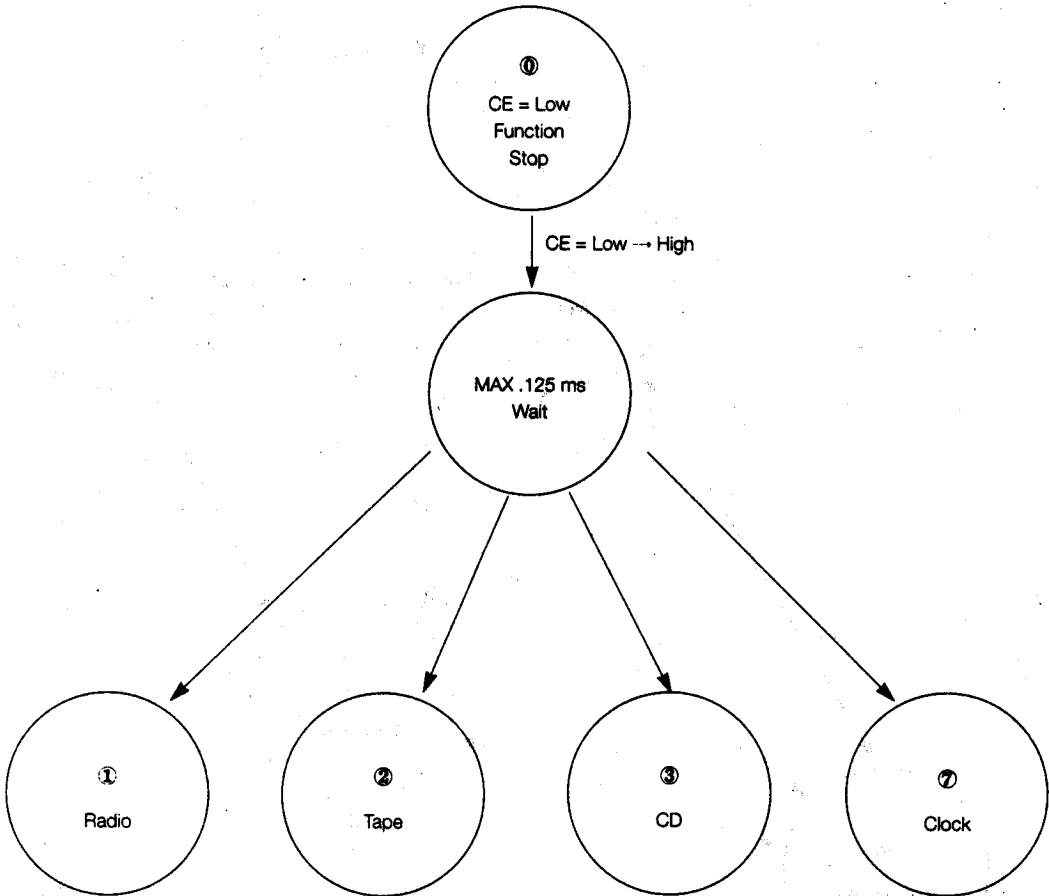

(2) CE : High Level

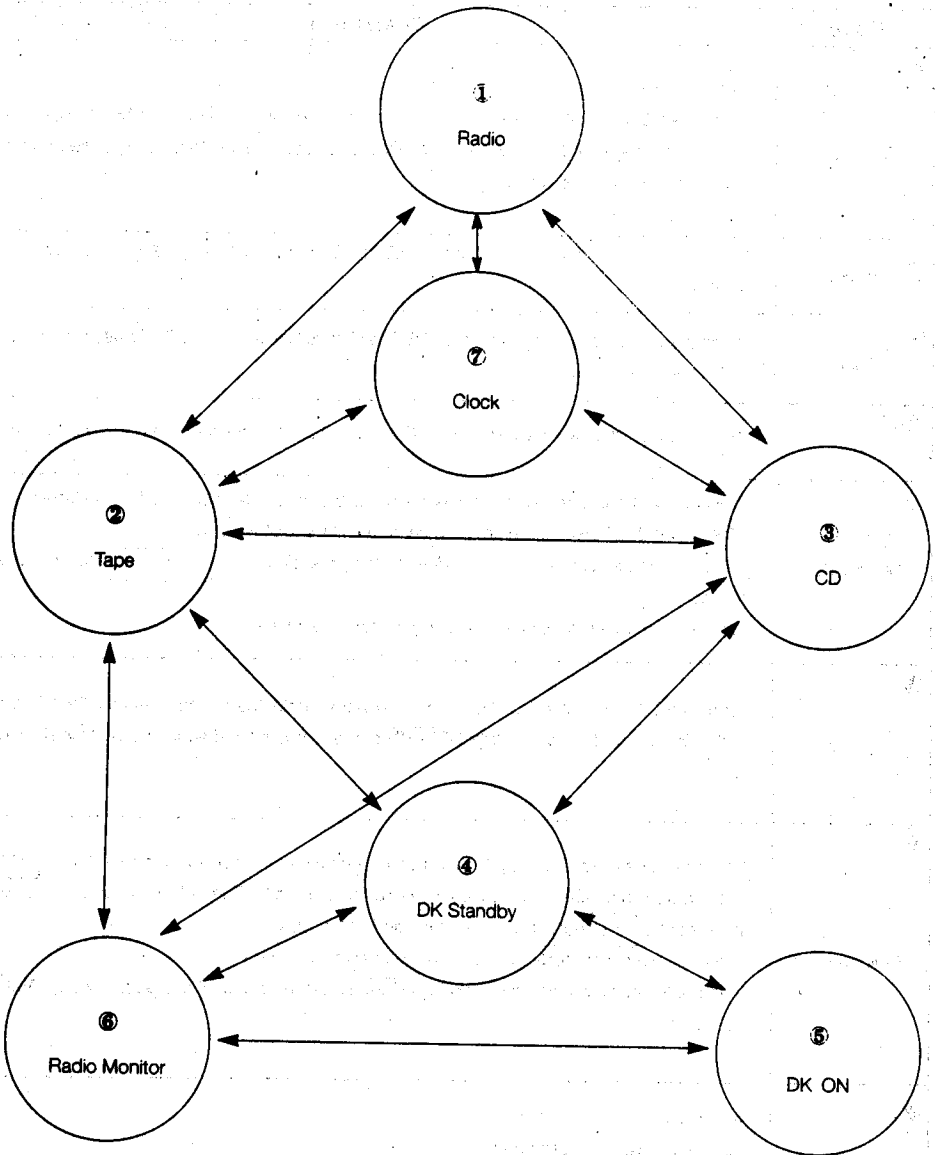

## 3.3 DESCRIPTION OF EACH MODE

Mode	Description
①  CE = Low	Backup mode. When the NOCLK switch is set to no clock, low consumption current(10 $\mu$ A Max.) backup is possible. When clock is selected, the device is set to the clock count mode. In the mode, the maximum consumption current is 500 $\mu$ A.
① Radio	When the CE pin is high level and the TPSET and CDSET switches are OFF, the device is set to the radio mode.
② Tape	When the CE pin is high level and the TPSET switch is ON and the CDSET switch is OFF, the device is set to the tape mode.
③ CD	When the CE pin is high level and the CDSET switch is ON, the device is set to the CD mode.
④  DK Standby	When the VF band is received in the radio mode and the mode is switched to the tape or CD mode by TPSET or CDSET switch, the device is set to the DK standby mode. The device is also set to the DK standby mode by pressing the <span style="border: 1px solid black; padding: 2px;">VF</span> key in the tape or CD modes. In the DK standby mode, VF band tuning operation is enabled.
⑤  D · K	When the DK switch is set to ON in the DK standby mode, the device enters the DK ON mode. In the DK ON mode, radio muting ( $\overline{\text{RDMUTE}}$ pin) is turned off and audio muting ( $\overline{\text{AMUTE}}$ pin) is turned on.
⑥  Radio monitor	When the tape mode is set by TPSET switch when the radio monitor mode is ON by <span style="border: 1px solid black; padding: 2px;">RDMONI</span> in the radio mode, the device enters the radio monitor mode. The radio monitor mode is also set by pressing the <span style="border: 1px solid black; padding: 2px;">RDMONI</span> key in the tape and CD modes. In the radio monitor mode, normal tuning operation is possible. In the radio monitor mode, radio muting ( $\overline{\text{RDMUTE}}$ pin) is turned off and audio muting ( $\overline{\text{AMUTE}}$ pin) is turned on.
⑦  Clock	NOCLK = 0 Only clock display is performed. Clock adjustment is also possible. NOCLK = 1 Function is disabled. However, since the CE is high level, the consumption current is 500 $\mu$ A Typ.

## 3.4 RADIO ON/OFF BY POWER KEY

The **POWER** key is invalid when CE pin is high level.

Each time the key is pressed, the POWER pin (pin 23) output is inverted.

Therefore, a circuit is configured so that the radio is turned on and off by setting RDON = 0 and turning the RDSSET switch on and off by POWER pin.

For details, see "Application Circuits".

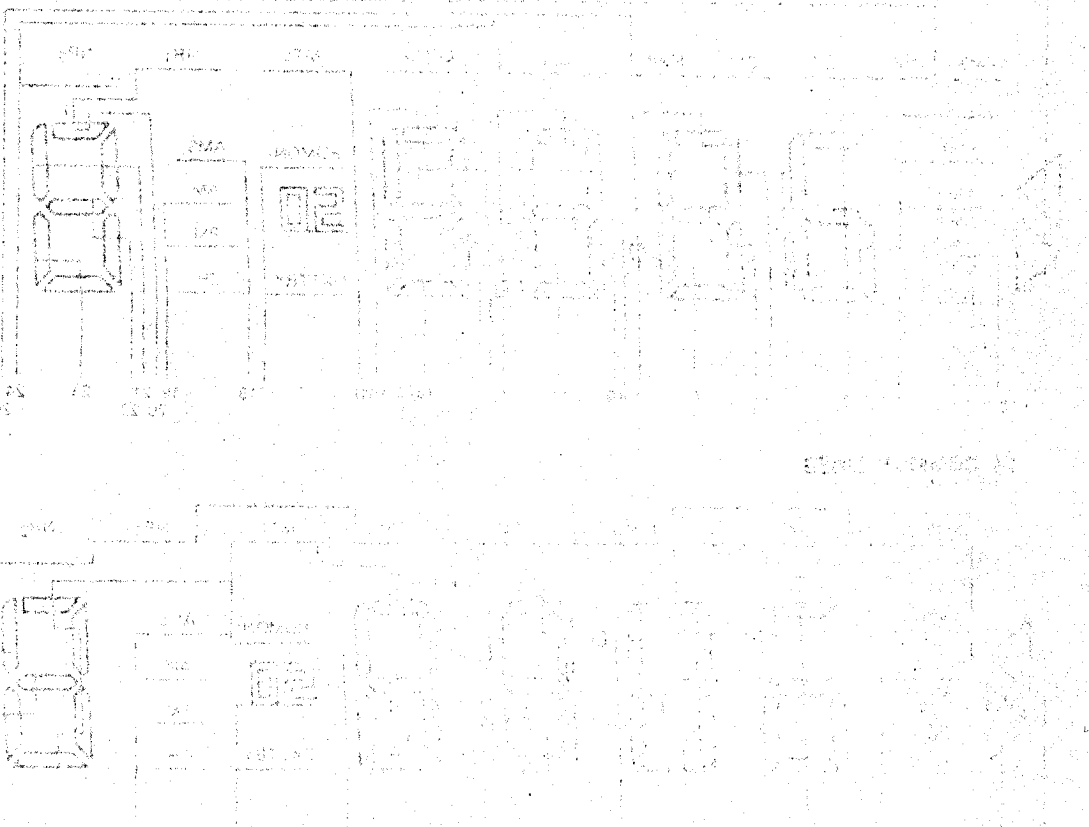



## 4. DISPLAY

### 4.1 LCD PANEL

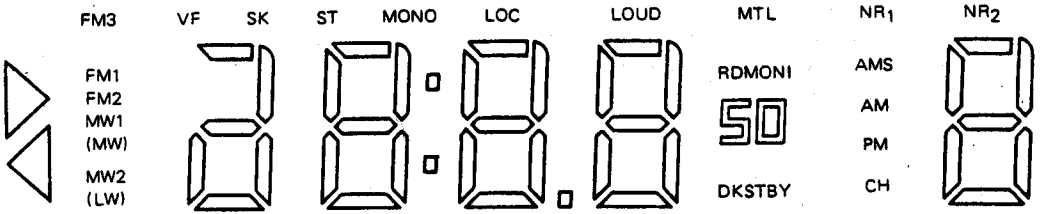

### 4.2 DISPLAY TYPE

1 2 3 4 5 6 7 8 9 0 Ld

### 4.3 SEGMENT LINES

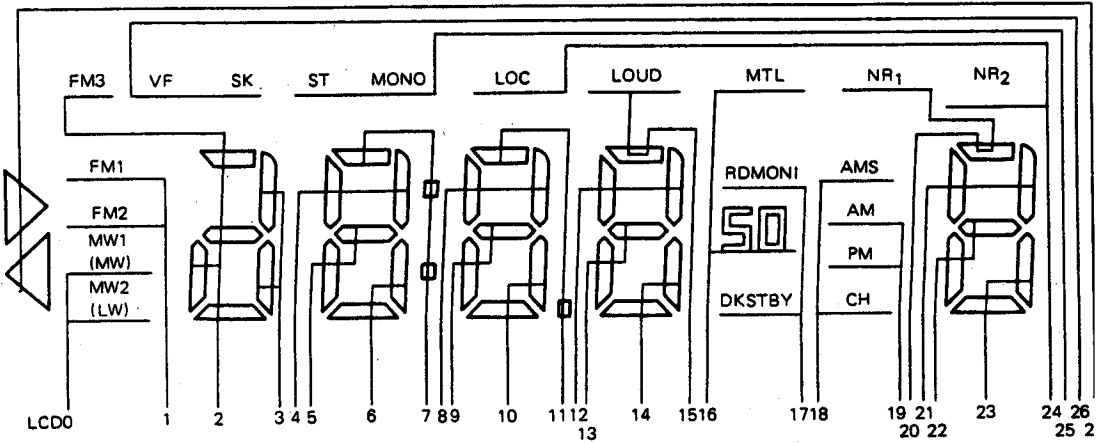

### 4.4 COMMON LINES

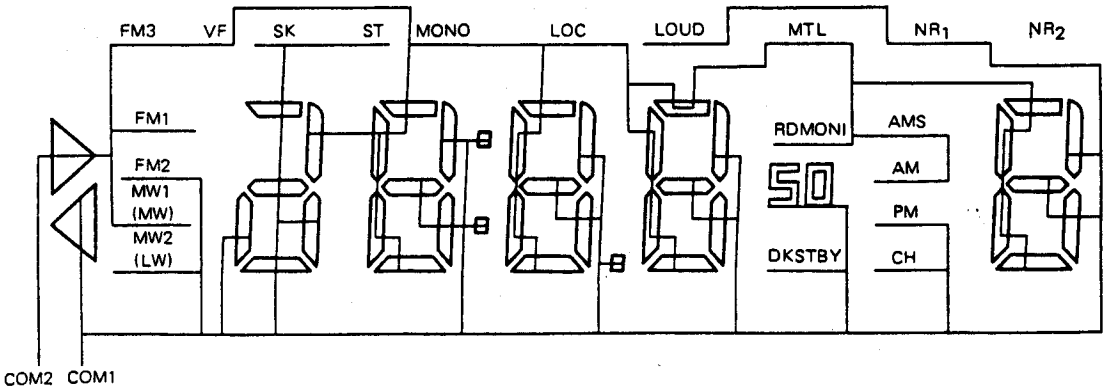

## 4.5 LCD ASSIGNMENT TABLE

LCD	COM1	COM2
0	MW2(LW)	MW1(MW)
1	FM2	FM1
2	4a, 4d, 4e, 4g	FM3
3	4c	4b
4	3b	3f
5	3g	3e
6	3c	3d
7	COLON(:)	3a
8	2b	2f
9	2g	2e
10	2c	2d
11	POINT(.)	2a
12	1b	1f
13	1g	1e
14	1c	1d
15	LOUD	1a
16	50	MTL
17	DKSTBY	RDMONI
18	CH	AMS
19	PM	AM
20	NR1	Ca
21	Cb	Cf
22	Cg	Ce
23	Cc	Cd
24	NR2	LOC
25	ST	MONO
26	SK	VF
27	<	>

FM3 VF SK ST MONO LOC LOUD MTL NR1 NR2

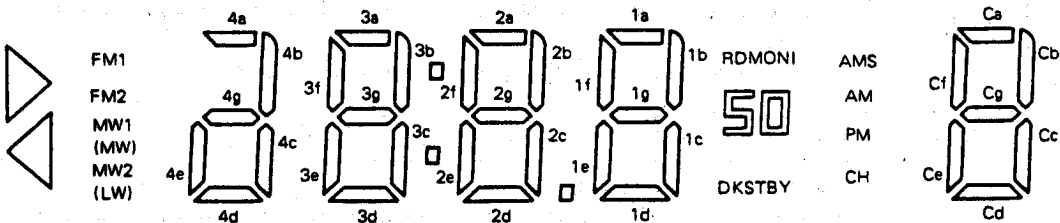

## 4.6 DESCRIPTION OF DISPLAYS

Display	Description
VF	Indicates that the device is on the VF band.
SK	Indicates that the SK signal is input. It lights when the SK switch is turned on at the FM and VF bands.
ST	Indicates that a STEREO signal is input. It lights when the $\overline{ST}$ pin (pin 64) becomes Low on the FM and VF bands. However, it does not light in the MONO mode.
MONO	Indicates that the device is in the monaural mode. When the <input type="checkbox"/> MONO key is pressed on the FM and VF bands, the display is inverted. High level is output from the MONO/NR <sub>2</sub> pin(pin 18) while this display is lit. It is invalid on the MW and LW bands.
LOC	Indicates that the device is in the LOCAL mode. When AUTOLOC = 0, when the <input type="checkbox"/> LOC key is pressed in a radio mode(FM, MW, LW bands), the display is inverted. When AUTCLOC = 1, this display lights during autotuning local search. High level is output from the LOC pin (pin 10) during autotuning while this display is lit.
LOUD	Indicates that the device is in the LOUDNESS state. When the <input type="checkbox"/> LOUD key is pressed in the radio, tape or CD mode, this display is inverted. High level is output from the LOUD pin (pin 19) while this display is lit.
MTL	Indicates that the device is in the METAL state. When the <input type="checkbox"/> METAL function key is pressed in the tape mode, this display is inverted. High level is output from the MTL pin (pin 21) while this display is lit.
NR <sub>1</sub>	Indicates that the device is in the NR <sub>1</sub> (Noise Reduction) state. When the device is placed into the NR <sub>1</sub> state by <input type="checkbox"/> NR function key in the tape mode, this display lights. High level is output from the NR <sub>1</sub> pin (pin 22) while this display is lit.
NR <sub>2</sub>	Indicates that the device is in the NR <sub>2</sub> (Noise Reduction) state. The NR <sub>2</sub> function can be used with the initialized diode ENNR <sub>2</sub> switch. When the device was placed into the NR <sub>2</sub> state by <input type="checkbox"/> NR function key in the tape mode, this display lights. High level is output from the MONO / NR <sub>2</sub> pin (pin 18) while this display is lit.
DKSTBY	Lights in the DK standby and DK ON modes in the tape/CD mode.
◁ ▷	Indicates the direction of tape travel. In the tape mode, this display indicates the tape direction according to the state of the RL switch. If the FF switch is ON, this display flashes. For more information, see the description of each pin.

# DMC 4001

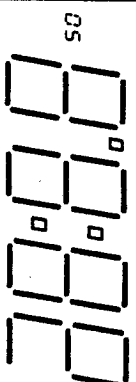
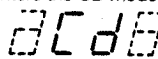
Display	Description
FM1 FM2 FM3 MW1(MW) MW2(LW)	Indicates the receiving band in the radio mode.  In Europe, when the device is switched to LW band, "MW2 (LW)" lights.
	Displays the receiving frequency CD and clock. <ul style="list-style-type: none"> <li>- Receiving frequency display Displayed in the radio mode. "50" is displayed only on the Europe and South Africa FM bands. "." (D.P) is displayed as the decimal point on the FM bands.</li> <li>- CD display When the device enters the CD mode, the following is displayed.</li> <li>- Clock display 12 hour clock or 24 hour clock can be selected by the initialized diode CLKDSP switch. Flashing of the ":" (colon) display is possible by the initialized diode FLASH switch.</li> </ul>
AMS	Indicates that the device is in the AMS (Auto Music Search) state. When the <span style="border: 1px solid black; padding: 2px;">AMS</span> function key is pressed in the tape mode, this display is inverted. High level is output from the AMS pin (pin 20) while this display is lit.
AM PM	12 hour clock AM and PM display.
	Indicates the preset memory number and AMS selection number. <ul style="list-style-type: none"> <li>- Preset memory number display. In the radio mode, when preset memory write and call are performed, the corresponding preset number and "ch" are displayed. In the memory write mode set by <span style="border: 1px solid black; padding: 2px;">ME</span> key, the "ch" display flashes at 1Hz. During preset memory scanning by <span style="border: 1px solid black; padding: 2px;">PSCAN</span> key, the preset memory number display (Ca to Cg) flashes at 1 Hz.</li> </ul>
RDMONI	Lights in the radio monitor mode.

## 5. RADIO MUTE OUTPUT TIMING (RDMUTE)

- ① Key ON chattering prevention
- ② Premuting and BEEP output
- ③ Division ratio setting and display contents updating
- ④ Postmuting
- ⑤ Scan time
- ⑥ PLL lock wait time

### 5.1 RADIO MUTE (RDMUTE PIN) OUTPUT TIMING CHARTS

1) Manual up/down

(1) 1 channel up/down

(a) AUTO 500 switch = 0

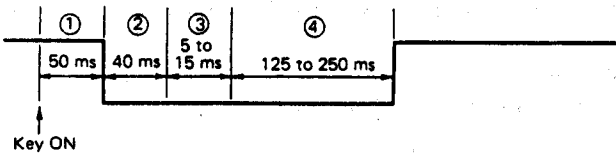

(b) AUTO 500 switch = 1

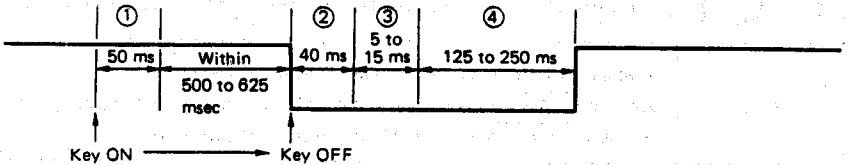

At the band edge (between lowest frequency and highest frequency) of both (a) and (b), time ④ is 625 to 750 ms.

(2) Continuous up/down

(a) AUTO 500 switch = 0.

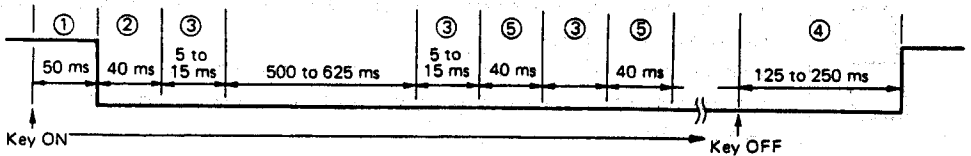

At the band edge, time ⑤ becomes 540 to 665 ms and time ④ becomes 625 to 750 ms.

(b) When AUTO 500 switch = 1, continuous up/down is not performed because holding down the key for more than 0.5 seconds sets autotuning.

## 2) Auto up / down

(1) **SEEK UP**, **SEEK DWN**, **SCAN UP**, **SEEK DWN** keys

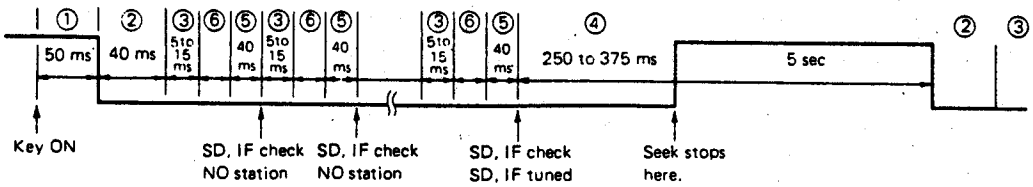

(2) **MAN UP**, **MAN DWN** key held down for more than 0.5 seconds when AUTO 500 switch = 1

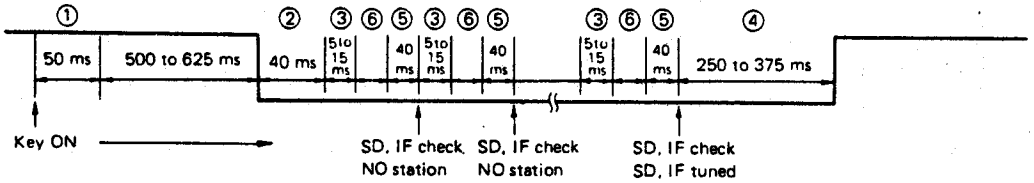

At both (1) and (2), at the band edge time (5) becomes 520 to 695 ms.

IF check is performed twice, once in the FAST mode and once in the SLOW mode.

FAST mode IF check takes approx. 6 ms on the FM, MW and LW bands and SLOW mode IF check takes approx. 15 ms on the FM band and approx. 25 ms on the MW and LW bands

## 3) Preset memory call

(1) M2S switch = 0

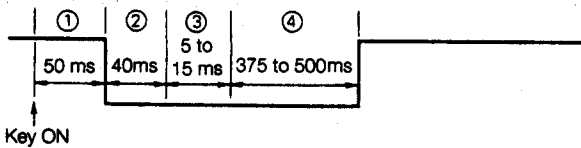

(2) M2S switch = 1

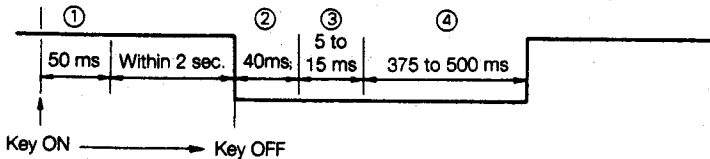

4) Preset memory write

(1) M2S switch = 0

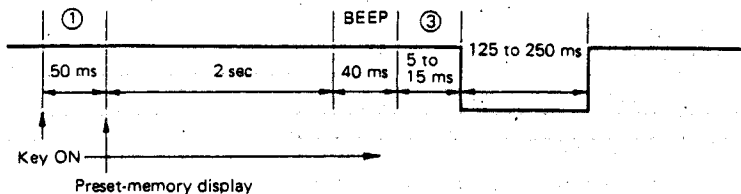

(2) When M2S switch = 1, muting is not output.

5) Preset memory scan

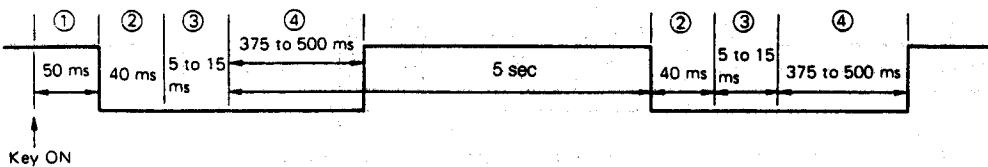

6) VF mode

(1) When VF mode selected with VF key ON

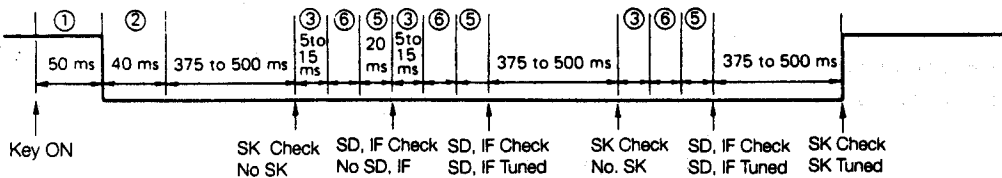

(2) Seek and scan operating in VF mode

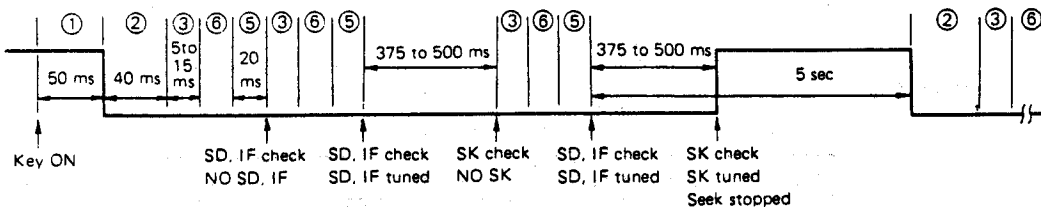

7) Band switching

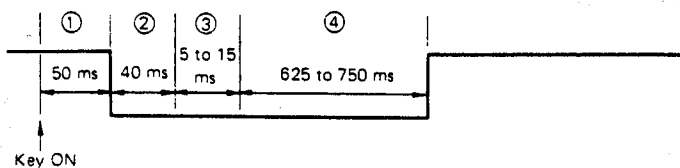

# DMC 4001

## 8) Radio OFF to ON

### (1) RDSET switch

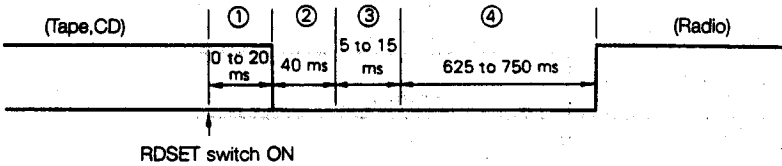

### (2) CE : Low to High by RDON switch = 1

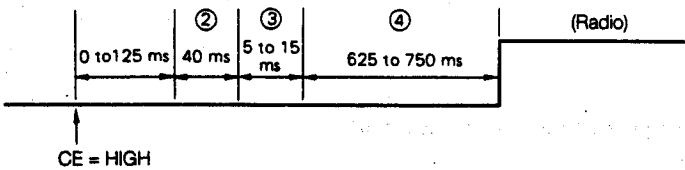

## 9) TAPE or CD OFF to ON

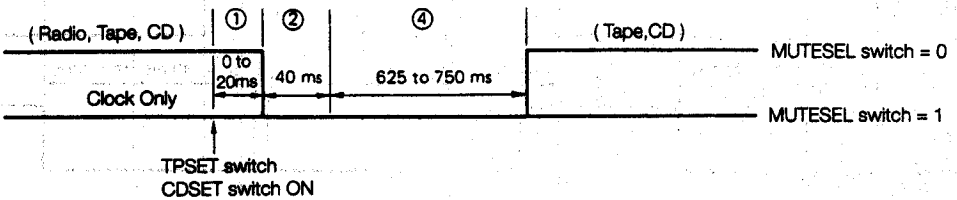

## 10) CE pin High to Low

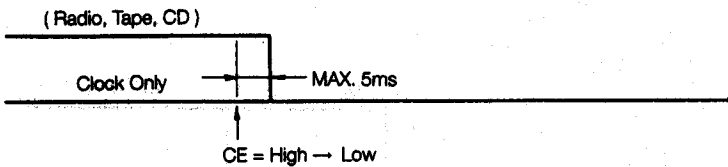



## 5.2 RADIO MUTE (RDMUTE PIN) AND AUDIO MUTE (AMUTE PIN) OUTPUT TIMING CHARTS

1) When switched from radio mode to tape or CD mode.

(Other than VF band, other than radio monitor mode)

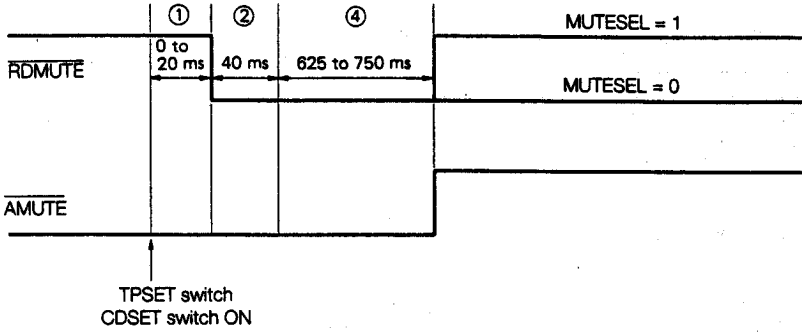

1) When switched from VF band to tape or CD mode (Set MUTESEL to 0)

(1) DK = OFF

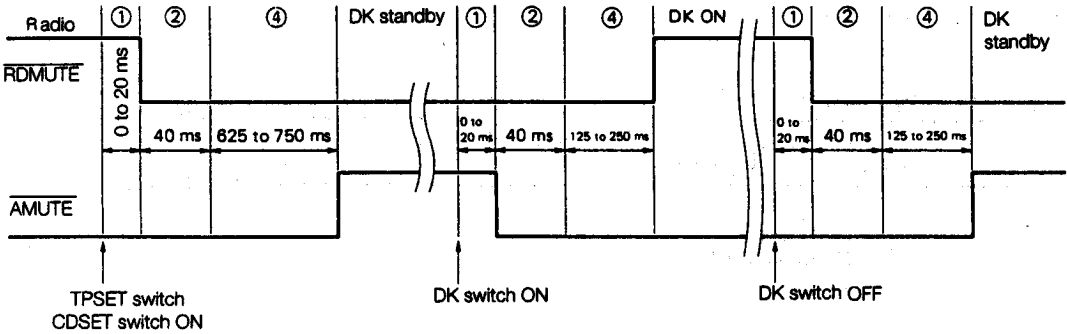

(2) DK = ON

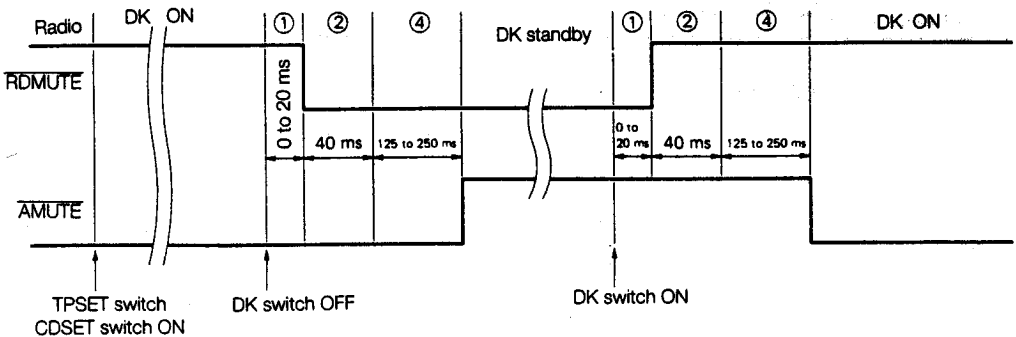

3) Radio monitor mode (Set MUTESEL to 0.)

(1) When switched from radio monitor OFF in the radio mode

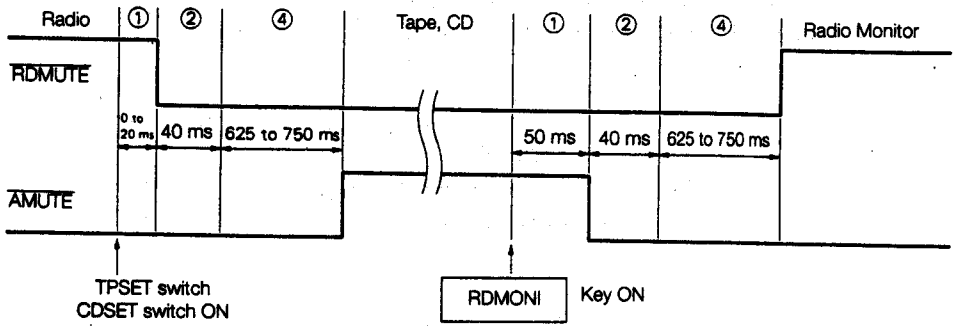

(2) When switched from radio monitor ON in radio mode

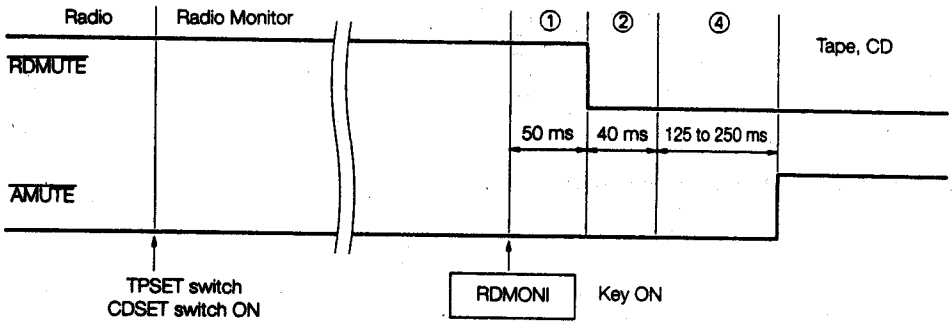

## 6. PIN I/O CIRCUITS

The I/O circuit of each pin of the DMC4001 is shown below in abbreviated form.

- (1) LCD<sub>0</sub> / KS<sub>0</sub> to LCD<sub>27</sub>, CGP, PB<sub>0</sub> to PB<sub>3</sub>, PD<sub>0</sub> to PD<sub>2</sub>, EO<sub>1</sub>, EO<sub>2</sub>

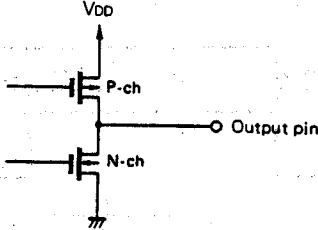

- (2) INT, AD

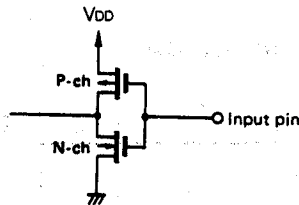

- (3) PA<sub>0</sub> / AMIF, PA<sub>1</sub> / FMIF, PA<sub>2</sub>, PA<sub>3</sub>, PC<sub>0</sub> to PC<sub>3</sub>

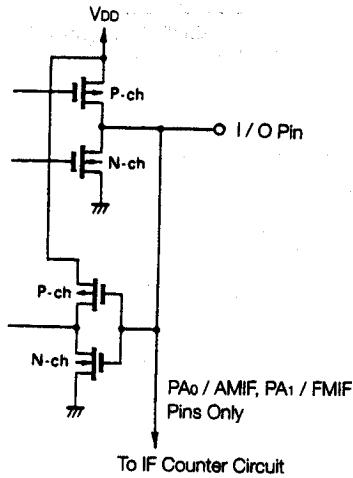



## 7. APPLICATION CIRCUITS

### 7.1 Power ON/OFF by alternate switch (No clock display in power OFF time)

RDON SWITCH = 1

RADIO ON (CE: Low to High)

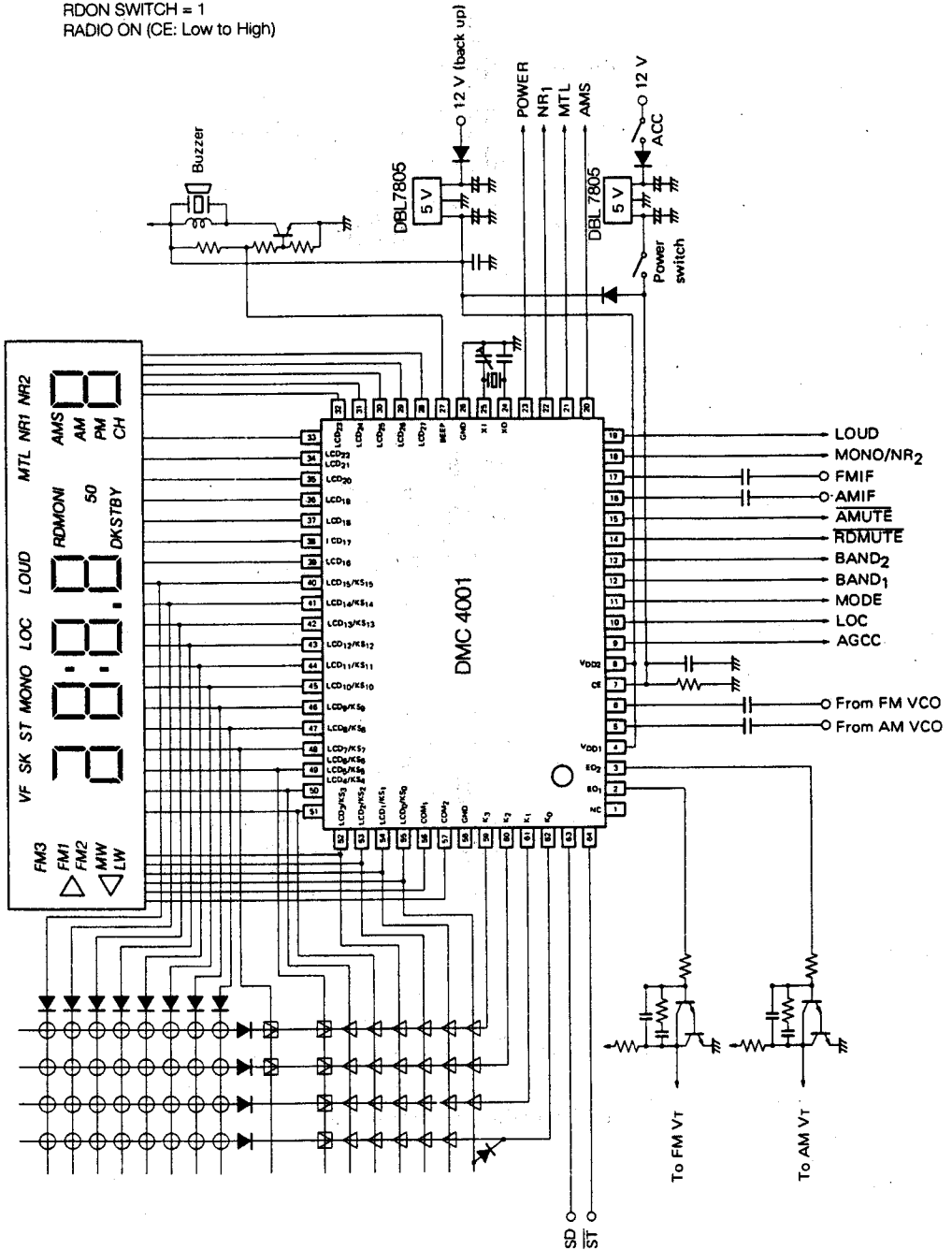

# DMC 4001

## 7.2 Power ON/OFF by alternate switch ( ) (Clock display in power on time)

RDSET switch is used.

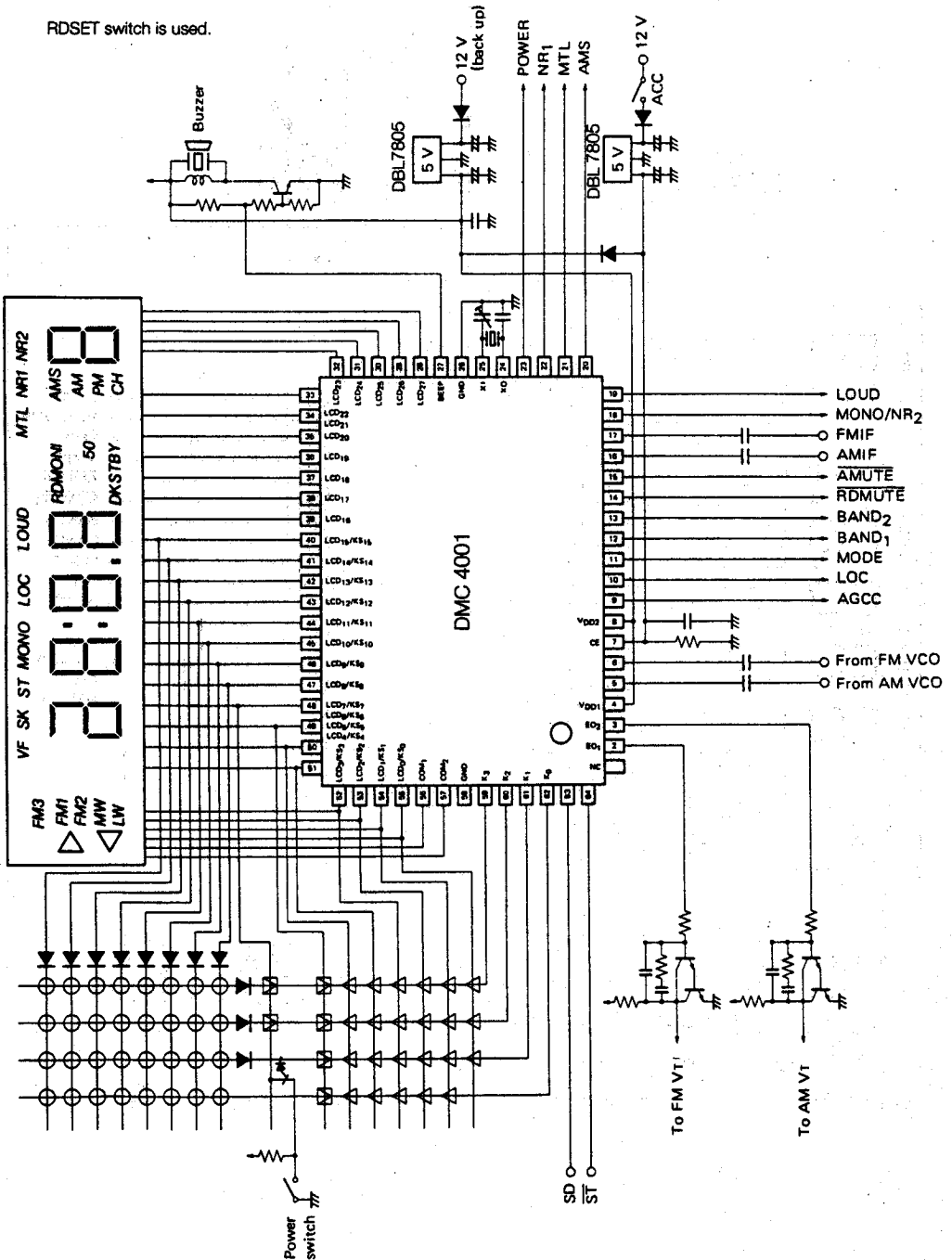

# DMC 4001

## 7.3 Power ON/OFF by momentary switch ( ) (Clock display in power Off time)

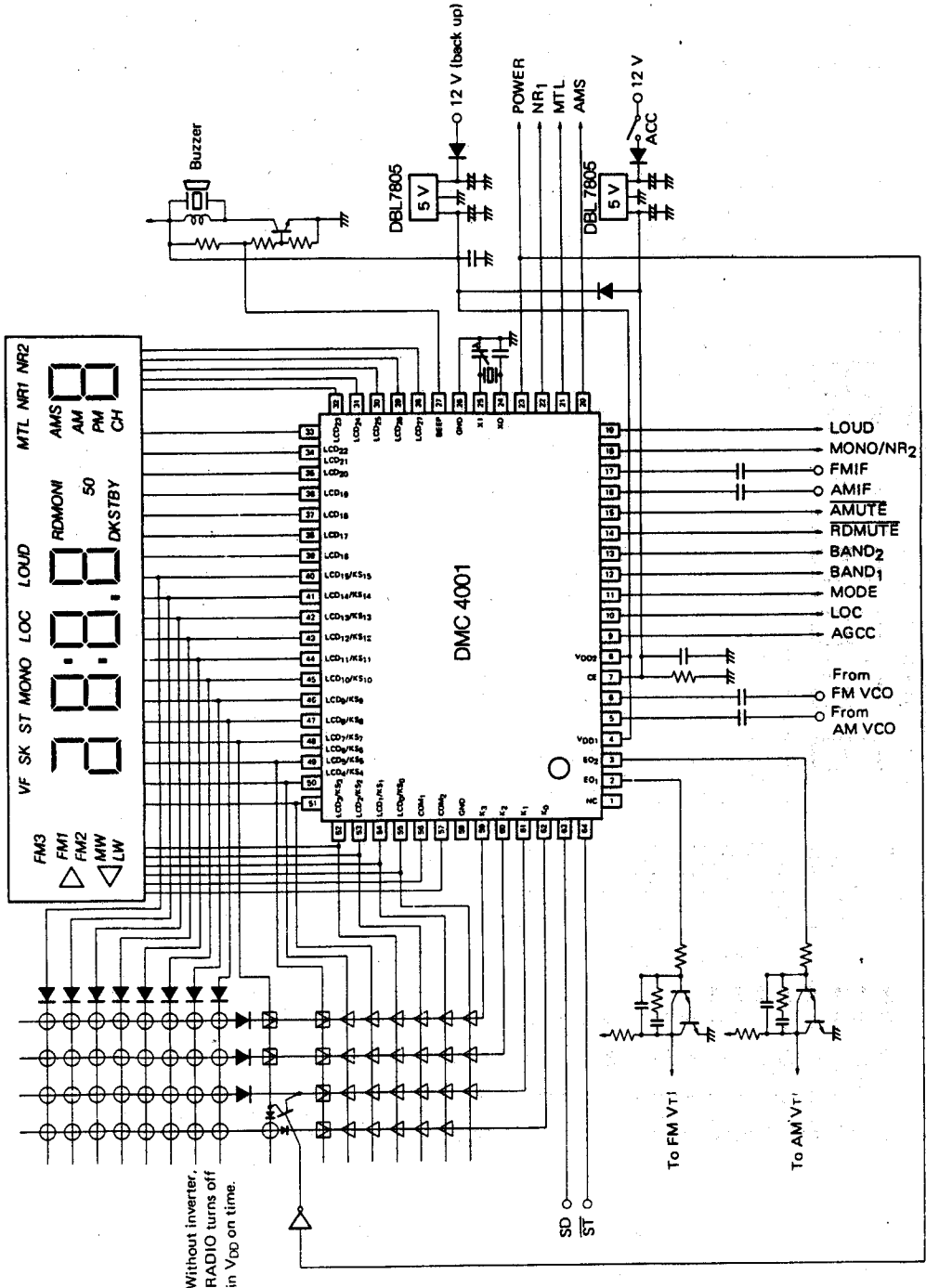

## 8. ELECTRICAL SPECIFICATIONS

### □ MAXIMUM RATINGS

Characteristic	Symbol	Rating	Unit
Supply Voltage	$V_{DD}$	-0.3 ~ 6.0	V
Input Voltage	$V_{IN}$	-0.3 ~ $V_{DD}^{+0.3}$	V
Output Voltage	$V_O$	-0.3 ~ $V_{DD}^{+0.3}$	V
Output Sink Current	$I_{SINK}$	10	mA
Operating Temperature	$T_a$	-40 ~ 85	°C
Storage Temperature	$T_{stg}$	-55 ~ 125	°C

### □ RECOMMENDED OPERATING RANGE

Characteristic	Symbol	Test Condition	Min.	Typ.	Max.	Unit
Supply Voltage	$V_{DD1}$	CPU, PLL operating	4.5	5	5.5	V
	$V_{DD2}$	PLL stopped	3.5	5	5.5	V
Date Hold Voltage	$V_{DR}$	X' tal oscillation stopped	2.4		5.5	V
Supply Voltage Rise Time	$T_{rise}$	$V_{DD} = \text{Low to High}$			500	ms
Input Amplitude	$V_{in1}$	FM VCO, AM VCO Pin	0.3		$V_{DD}$	$V_{p-p}$
Output Amplitude	$V_{in2}$	AMIF, FMIF pin	0.1		$V_{DD}$	$V_{p-p}$

### □ AC CHARACTERISTICS

(Unless otherwise specified,  $T_a = 25^\circ\text{C}$ ,  $V_{DD} = 4.5$  to  $5.5\text{V}$ )

Characteristic	Symbol	Test Condition	Min.	Typ.	Max.	Unit
Operating Frequency	$f_{in1}$	FM VCO pin (positive sine wave input) $V_{in} = 0.3V_{p-p}$	10		200	MHz
	$f_{in2}$	AM VCO pin (positive sine wave input) $V_{in} = 0.3V_{p-p}$	0.50		30	MHz
	$f_{in3}$	FMIF pin (positive sine wave input) $V_{in} = 0.1V_{p-p}$	1		20	MHz
	$f_{in4}$	AMIF pin (positive sine wave input) $V_{in} = 0.1V_{p-p}$	0.3		5	MHz



# DMC 4001

## □ DC CHARACTERISTICS

(Unless otherwise specified,  $T_a = 25^\circ\text{C}$ ,  $V_{DD} = 4.5$  to  $5.5\text{V}$ )

Characteristic	Symbol	Test Condition	Min.	Typ.	Max.	Unit
Input Voltage High	$V_{IH1}$	PORT A / C	$0.7 V_{DD}$			V
	$V_{IH2}$	CE, $\overline{\text{INT}}$	$0.8 V_{DD}$			V
	$V_{IH3}$	$K_3$ to $K_0$	$0.6 V_{DD}$			V
Input Voltage Low	$V_{IL1}$	PORT A / C, CE, $\overline{\text{INT}}$			$0.2 V_{DD}$	V
	$V_{IL2}$	$K_3$ to $K_0$			$0.15V_{DD}$	V
Output Current High	$I_{OH1}$	PORT A / B / C / D $V_{OH} = V_{DD} - 0.4\text{V}$	-0.4			mA
	$I_{OH2}$	EO <sub>1</sub> , EO <sub>2</sub> , CGP, LCD <sub>27</sub> to LCD <sub>24</sub> $V_{OH} = V_{DD} - 1\text{V}$	-0.5			mA
	$I_{OH3}$	LCD <sub>0</sub> to LCD <sub>23</sub> $V_{OL} = V_{DD} - 1\text{V}$	-200	-280		$\mu\text{A}$
Output Current Low	$I_{OL1}$	PORT A / B / C / D, CGP, LCD <sub>27</sub> to LCD <sub>24</sub> $V_{OH} = 0.4\text{V}$	0.6			mA
	$I_{OL2}$	EO <sub>1</sub> , EO <sub>2</sub> $V_{OL} = 1\text{V}$	0.5			mA
	$I_{OL3}$	LCD <sub>0</sub> to LCD <sub>23</sub> $V_{OL} = 1\text{V}$	200	300		$\mu\text{A}$
Input Current High	$I_{IH1}$	$K_3$ to $K_0$ $V_1 = V_{DD} = 4.5\text{V}$	15	120	200	$\mu\text{A}$
	$I_{IH2}$	FM / AM VCO, XI $V_1 = V_{DD} = 4.5\text{V}$	100			$\mu\text{A}$
Output Voltage	$V_{COM1}$	COM1, COM2 $V_{DD} = 5\text{V}$ , output open	4.8	5.0		V
	$V_{COM2}$	COM1, COM2 $V_{DD} = 5\text{V}$ , output open	2.3	2.5	2.7	V
	$V_{COM3}$	COM1, COM2 $V_{DD} = 5\text{V}$ , output open	0	0.2		V
Output off Leakage Current	$I_{LEAK}$	EO <sub>1</sub> , EO <sub>2</sub> $V_0 = V_{DD}$ , $T_a = 25^\circ\text{C}$		$10^{-3}$	1	$\mu\text{A}$
A/D Converter Resolution					6	bit
A/D Converter Absolute Accuracy		$T_a = -10$ to $+50^\circ\text{C}$		1	1.5	LSB
Supply Current	$I_{DD1}$	CPU and PLL operating ( $f_{in} = 150\text{MHz}$ ) $V_{DD} = 5\text{V}$ , $T_a = 25^\circ\text{C}$		20		mA
	$I_{DD2}$	PLL stopped, CPU operating $V_{DD} = 5\text{V}$ , $T_a = 25^\circ\text{C}$		0.5		mA
Data Hold Current	$I_{DH}$	X'tal oscillation stopped, $T_a = 25^\circ\text{C}$ $V_{DD} = 5\text{V}$		3	10	$\mu\text{A}$
AD Input Resistance	$R_1$		1			M $\Omega$

# DMC 4001

## 9. PACKAGE DIMENSION

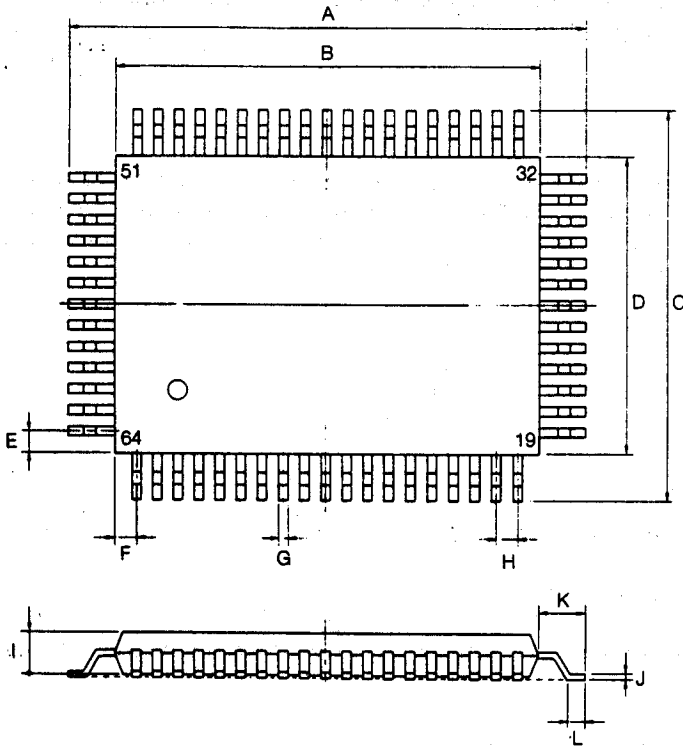

detail of lead end

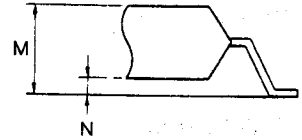

	MILLIMETER			INCH		MILLIMETER			INCH
	Min.	Typ.	Max.	Typ.		Min.	Typ.	Max.	Typ.
A	23.4	23.86	24.2	.939	H	—	1.0	—	.039
B	19.85	20.0	20.15	.787	I	2.6	2.71	2.8	.107
C	17.4	17.86	18.2	.703	J	0.13	0.15	0.2	.006
D	13.85	14.0	14.15	.551	K	1.7	1.93	2.1	.076
E	—	1.0	—	.039	L	0.4	0.51	0.7	.02
F	—	1.0	—	.039	M	—	2.91	3.15	.115
G	0.3	0.4	0.5	.016	N	0.0	0.2	0.35	.008